

**dbx**<sup>®</sup> *PROFESSIONAL PRODUCTS*

# iEQ

Dual Channel Digital Graphic EQ/Limiter w/Type V™ NR and AFS™



**iEQ-15**  
**iEQ-31**

**H** A Harman International Company

*User Manual*

# IMPORTANT SAFETY INSTRUCTIONS

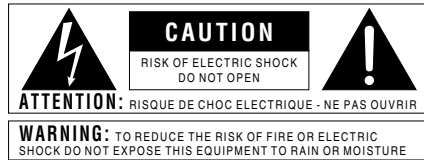

The symbols shown above are internationally accepted symbols that warn of potential hazards with electrical products. The lightning flash with arrowpoint in an equilateral triangle means that there are dangerous voltages present within the unit. The exclamation point in an equilateral triangle indicates that it is necessary for the user to refer to the owner's manual.

These symbols warn that there are no user serviceable parts inside the unit. Do not open the unit. Do not attempt to service the unit yourself. Refer all servicing to qualified personnel. Opening the chassis for any reason will void the manufacturer's warranty. Do not get the unit wet. If liquid is spilled on the unit, shut it off immediately and take it to a dealer for service. Disconnect the unit during storms to prevent damage.

## SAFETY INSTRUCTIONS

NOTICE FOR CUSTOMERS IF YOUR UNIT IS EQUIPPED WITH A POWER CORD.

WARNING: THIS APPLIANCE MUST BE EARTHED.

The cores in the mains lead are coloured in accordance with the following code:

GREEN and YELLOW - Earth    BLUE - Neutral    BROWN - Live

As colours of the cores in the mains lead of this appliance may not correspond with the coloured markings identifying the terminals in your plug, proceed as follows:

- The core which is coloured green and yellow must be connected to the terminal in the plug marked with the letter E, or with the earth symbol, or coloured green, or green and yellow.
- The core which is coloured blue must be connected to the terminal marked N or coloured black.
- The core which is coloured brown must be connected to the terminal marked L or coloured red.

This equipment may require the use of a different line cord, attachment plug, or both, depending on the available power source at installation. If the attachment plug needs to be changed, refer servicing to qualified service personnel who should refer to the table below. The green/yellow wire shall be connected directly to the units chassis.

CONDUCTOR	WIRE COLOR		
		Normal	Alt
L	LIVE	BROWN	BLACK
N	NEUTRAL	BLUE	WHITE
E	EARTH GND	GREEN/YEL	GREEN

WARNING: If the ground is defeated, certain fault conditions in the unit or in the system to which it is connected can result in full line voltage between chassis and earth ground. Severe injury or death can then result if the chassis and earth ground are touched simultaneously.

## WARNING FOR YOUR PROTECTION READ THESE INSTRUCTIONS:

**KEEP THESE INSTRUCTIONS**

**HEED ALL WARNINGS**

**FOLLOW ALL INSTRUCTIONS**

**DO NOT USE THIS APPARATUS NEAR WATER**

**CLEAN ONLY WITH A DRY CLOTH.**

**DO NOT BLOCK ANY OF THE VENTILATION OPENINGS. INSTALL IN ACCORDANCE WITH THE MANUFACTURER'S INSTRUCTIONS.**

**DO NOT INSTALL NEAR ANY HEAT SOURCES SUCH AS RADIATORS, HEAT REGISTERS, STOVES, OR OTHER APPARATUS (INCLUDING AMPLIFIERS) THAT PRODUCE HEAT.**

**ONLY USE ATTACHMENTS/ACCESSORIES SPECIFIED BY THE MANUFACTURER.**

**UNPLUG THIS APPARATUS DURING LIGHTNING STORMS OR WHEN UNUSED FOR LONG PERIODS OF TIME.**

**Do not defeat the safety purpose of the polarized or grounding-type plug. A polarized plug has two blades with one wider than the other. A grounding type plug has two blades and a third grounding prong. The wide blade or third prong are provided for your safety. If the provided plug does not fit your outlet, consult an electrician for replacement of the obsolete outlet.**

**Protect the power cord from being walked on or pinched particularly at plugs, convenience receptacles, and the point where they exit from the apparatus.**

**Use only with the cart stand, tripod bracket, or table specified by the manufacture, or sold with the apparatus. When a cart is used, use caution when moving the cart/apparatus combination to avoid injury from tip-over.**



**Refer all servicing to qualified service personnel. Servicing is required when the apparatus has been damaged in any way, such as power-supply cord or plug is damaged, liquid has been spilled or objects have fallen into the apparatus, the apparatus has been exposed to rain or moisture, does not operate normally, or has been dropped.**

**POWER ON/OFF SWITCH:** For products provided with a power switch, the power switch **DOES NOT** break the connection from the mains.

**MAINS DISCONNECT:** The plug shall remain readily operable. For rack-mount or installation where plug is not accessible, an all-pole mains switch with a contact separation of at least 3 mm in each pole shall be incorporated into the electrical installation of the rack or building.

**FOR UNITS EQUIPPED WITH EXTERNALLY ACCESSIBLE FUSE RECEPTACLE:** Replace fuse with same type and rating only.

**MULTIPLE-INPUT VOLTAGE:** This equipment may require the use of a different line cord, attachment plug, or both, depending on the available power source at installation. Connect this equipment only to the power source indicated on the equipment rear panel. To reduce the risk of fire or electric shock, refer servicing to qualified service personnel or equivalent.

**This Equipment is intended for rack mount use only.**

# IMPORTANT SAFETY INSTRUCTIONS

## ELECTROMAGNETIC COMPATIBILITY

This unit conforms to the Product Specifications noted on the **Declaration of Conformity**. Operation is subject to the following two conditions:

- this device may not cause harmful interference, and
- this device must accept any interference received, including interference that may cause undesired operation.

Operation of this unit within significant electromagnetic fields should be avoided.

- use only shielded interconnecting cables.

## U.K. MAINS PLUG WARNING

A molded mains plug that has been cut off from the cord is unsafe. Discard the mains plug at a suitable disposal facility. **NEVER UNDER ANY CIRCUMSTANCES SHOULD YOU INSERT A DAMAGED OR CUT MAINS PLUG INTO A 13 AMP POWER SOCKET.** Do not use the mains plug without the fuse cover in place. Replacement fuse covers can be obtained from your local retailer. Replacement fuses are 13 amps and MUST be ASTA approved to BS1362.

## **DECLARATION OF CONFORMITY**

Manufacturer's Name: dbx Professional Products  
Manufacturer's Address: 8760 S. Sandy Parkway  
Sandy, Utah 84070, USA

declares that the product:

Product name: dbx iEQ 15 & dbx iEQ31  
Note: Product name may be suffixed by the letters-EU.

Product option: None

conforms to the following Product Specifications:

Safety: IEC 60065 (1998)  
EMC: EN 55013 (1990)  
EN 55020 (1991)

Supplementary Information:

The product herewith complies with the requirements of the Low Voltage Directive 72/23/EEC and the EMC Directive 89/336/EEC as amended by Directive 93/68/EEC.

Vice-President of Engineering  
8760 S. Sandy Parkway  
Sandy, Utah 84070, USA  
Date: March 26, 2003

European Contact: Your local dbx Sales and Service Office or

Harman Music Group  
8760 South Sandy Parkway  
Sandy, Utah  
84070 USA  
Ph: (801) 566-8800  
Fax: (801) 568-7583

**Table of Contents**

Defining the iEQ .....	i
Service Contact Info .....	ii
Warranty .....	ii
Installation Recommendations .....	1
Power Up Quick Key Options .....	1
Rear Panel Connections .....	3
Front Panel Connections .....	3
Basic Connection .....	6
Block Diagram .....	7
Specifications .....	8



## INTRODUCTION

Congratulations on your purchase of the dbx Professional Products iEQ Series Graphic Equalizer/Limiter with Type V™ noise reduction and AFS™. With an EQ heritage that has produced countless industry standard patents and dates back more than 30 years, the dbx iEQ 15 and iEQ 31 easily live up to the dbx legacy of uncompromised sonic integrity. In addition to unsurpassed equalization specs, the iEQ series also offer built-in necessities which include AFS™ Feedback Suppression, Type V™ Noise reduction and PeakStopPlus® limiting. Besides including two 15-Band channels, 2/3 octave (iEQ 15) and two 31-band channels (iEQ 31) of 1/3-octave equalization, the iEQ 15 and iEQ 31 also offer  $\pm 12$  dB input gain range; switchable  $\pm 6$  or  $\pm 15$  dB boost/cut range, 40mm faders, XLR, 1/4" and Euroblock inputs and outputs, non-conductive nylon sliders; and an intuitive user interface with comprehensive output and gain reduction metering. As always, the inevitable result of our meticulous attention to detail and top-quality componentry is exceptional sound, performance, and reliability.

This manual will be your guide to understanding the full functionality of the powerful iEQ series. After you have become familiar with the unit, we encourage you to experiment and find creative ways that the iEQ series can help you optimize your specific application.

## Defining the iEQ

The dbx iEQ Series Graphic Equalizer provide the user with the following features:

- **Advanced Feedback Suppression (AFS™)**
- **Type V™ Noise Reduction**
- **PeakStopPlus® Limiting**
- **1/3 & 2/3-octave Constant Q frequency bands**
- **Switchable boost/cut ranges of  $\pm 6$  or  $\pm 15$  dB**
- **18 dB per octave 40Hz low-cut filter**
- **$\pm 12$  dB input gain range**
- **XLR, TRS and Euroblock Inputs and Outputs**
- **Internal Toroidal Transformer**
- **Dynamic range of greater than 113dB**
- **User Power Up Features**
- **Relay Bypass for Power Failure System Protection**

**Service Contact Info**

If you require technical support, contact dbx Customer Service. Be prepared to accurately describe the problem. Know the serial number of your unit - this is printed on a sticker attached to the top panel. If you have not already taken the time to fill out your warranty registration card and send it in, please do so now.

Before you return a product to the factory for service, we recommend you refer to the manual. Make sure you have correctly followed installation steps and operation procedures. If you are still unable to solve a problem, contact our Customer Service Department at (801) 568-7660 for consultation. If you need to return a product to the factory for service, you **MUST** contact Customer Service to obtain a Return Authorization Number.

No returned products will be accepted at the factory without a Return Authorization Number.

Please refer to the Warranty information on the following page, which extends to the first end-user. After expiration of the warranty, a reasonable charge will be made for parts, labor, and packing if you choose to use the factory service facility. In all cases, you are responsible for transportation charges to the factory. dbx will pay return shipping if the unit is still under warranty.

Use the original packing material if it is available. Mark the package with the name of the shipper and with these words in red: DELICATE INSTRUMENT, FRAGILE! Insure the package properly. Ship prepaid, not collect. Do not ship parcel post.

**Warranty**

This warranty is valid only for the original purchaser and only in the United States.

1. The warranty registration card that accompanies this product must be mailed within 30 days after purchase date to validate this warranty. Proof-of-purchase is considered to be the burden of the consumer.
2. dbx warrants this product, when bought and used solely within the U.S., to be free from defects in materials and workmanship under normal use and service.
3. dbx liability under this warranty is limited to repairing or, at our discretion, replacing defective materials that show evidence of defect, provided the product is returned to dbx WITH RETURN AUTHORIZATION from the factory, where all parts and labor will be covered up to a period of two years. A Return Authorization number must be obtained from dbx by telephone. The company shall not be liable for any consequential damage as a result of the product's use in any circuit or assembly.
4. dbx reserves the right to make changes in design or make additions to or improvements upon this product without incurring any obligation to install the same additions or improvements on products previously manufactured.
5. The foregoing is in lieu of all other warranties, expressed or implied, and dbx neither assumes nor authorizes any person to assume on its behalf any obligation or liability in connection with the sale of this product. In no event shall dbx or its dealers be liable for special or consequential damages or from any delay in the performance of this warranty due to causes beyond their control.

### Installation Recommendations

**FOR RACK MOUNT USE ONLY** - Install the iEQ in your rack with the provided rack screws. When installed in a rack, the unit should be positioned with enough room (at least one 1U above the and 1U below the unit) to allow proper ventilation. The iEQ should not be mounted above or below anything that generates excessive heat. Ambient temperatures should not exceed 113°F (45°C) when equipment is in use. Although the unit is shielded against radio frequency and electromagnetic interference, extremely high fields of RF and EMI should be avoided where possible.

### User Power-Up Modes

Unlike conventional graphic equalizers of the past, the iEQ Series EQs offer you the ability to lockout access to frequency slider manipulation and reset AFS filter settings. The procedure for these functions are as follows:

#### 1. Entry

While applying power, press and hold the **<AFS>** button on CHANNEL 1 until the following LED display sequence pattern on Ch1 Meters briefly appears:



#### 2. Menus

To select any one of the three available option (which are: 1. System Lockout 2. Live Filter Lift Time Menu, and 3. AFS Normal vs. 6-Fixed/6-Live Menu), press the **<AFS>** button on CHANNEL 1 to select through 1 of 3 menus. The meter LEDs appear as follow:

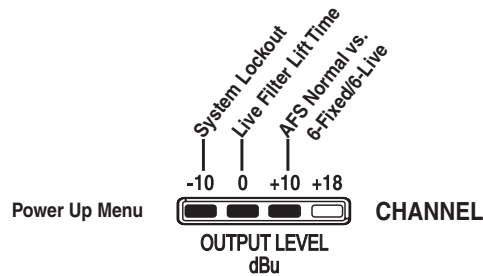

#### 3. Selections

**System Lockout** - Press the **<AFS>** button on CHANNEL 2 to select through selections within menus. The selections for System Lockout are : System Unlocked and System Locked and will be represented by a lit LED once selected. The following illustration show the selections and the corresponding LEDs indicators:

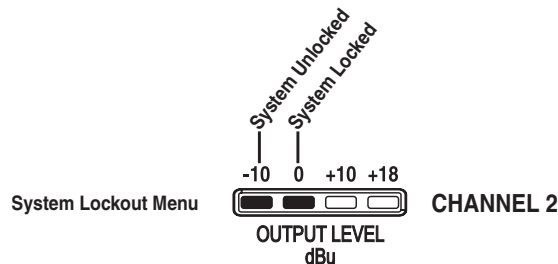



**Live Filter Lift Time Menu** - Press the **<AFS>** button on CHANNEL 2 to select through selections within menus. The selections for System Lockout are: Live Filter Lift Off, Live Filter Lift Short and Live Filter Lift Long, and will be represented by a lit LED once selected. The following illustration show the selections and the corresponding LEDs indicators:

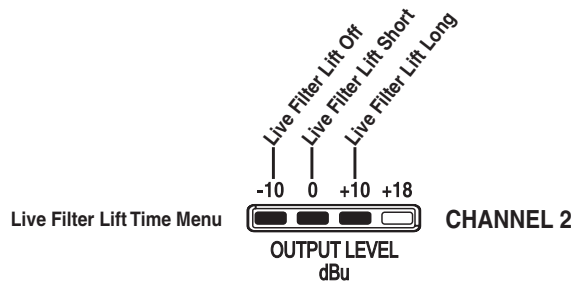

**AFS Normal vs. 6-Fixed/6-Live** - Press the **<AFS>** button on CHANNEL 2 to select through selections within menus. The selections for System Lockout are: AFS Normal Mode (All 12 filters are live) and AFS Normal vs 6-Fixed/6-Live Menu, and will be represented by a lit LED once selected. The Fixed filters stay closed until cleared, and live filters continuously update in the order that they were set. The following illustration show the selections and the corresponding LEDs indicators:

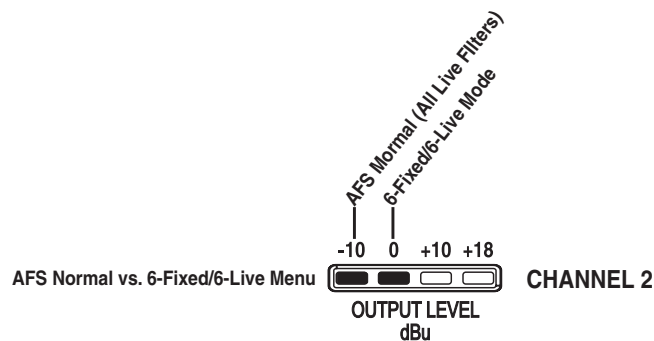

#### 4. Exit

Once your selections have been made, press and hold the **<AFS>** button on CHANNEL 1 until Filter Clear LED Sequence on CH1 Meters appears to exit.

### Rear Panel Connections

#### iEQ15 - dual channel 15 band graphic equalizer

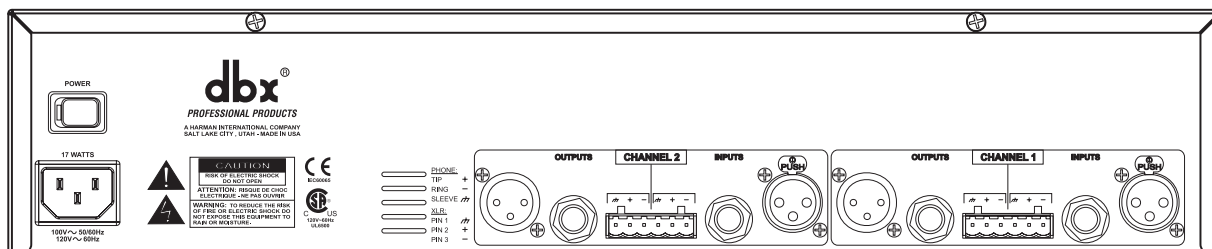

#### iEQ31 - dual channel 31 band graphic equalizer

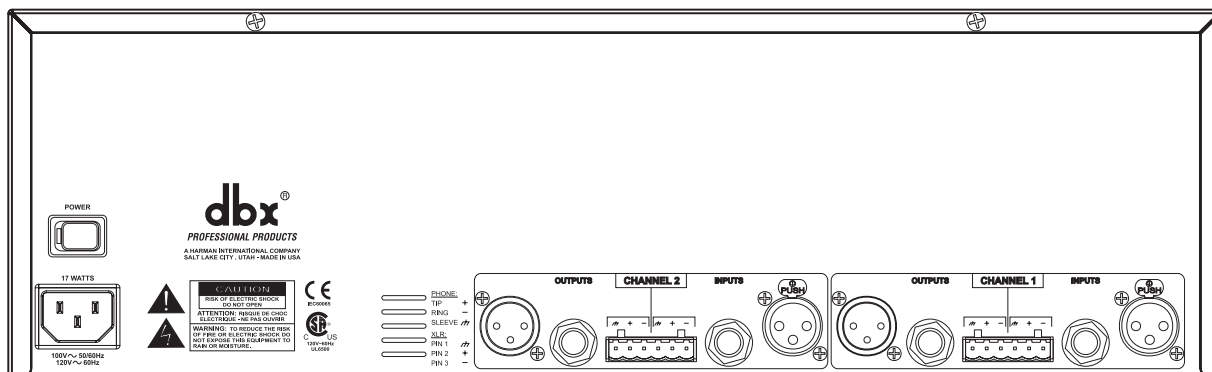

**Power Cord Receptacle:** Connects AC power to the equalizer.

**Power Switch:** Switches the power on and off. Always make audio connections with the power switch in the off position.

**Input Connectors:** Three types of input connectors are provided for input connections: female locking XLR type connectors, 1/4" tip-ring-sleeve phone jack connectors, and Euroblock. The maximum input level that the equalizer can accept is +20dBu (ref: 0.775Vrms).

**Output Connectors:** Three types of output connectors are provided for output connections: male XLR type connectors, 1/4" tip-ring-sleeve phone jack connectors and Euroblock.

### Front Panel Connections

#### iEQ15 - dual channel 15 band graphic equalizer

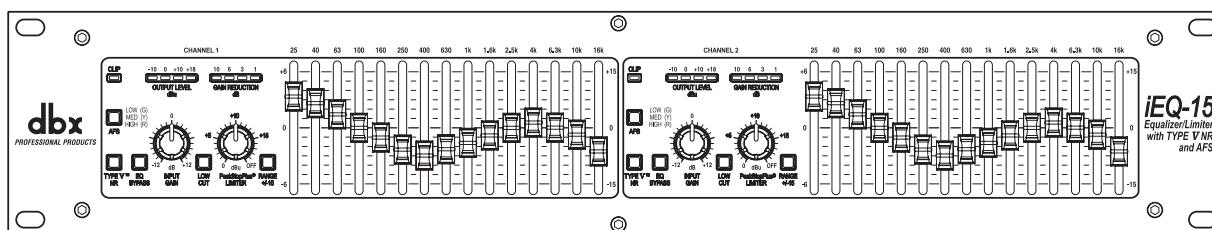

**iEQ31 - dual channel 31 band graphic equalizer**

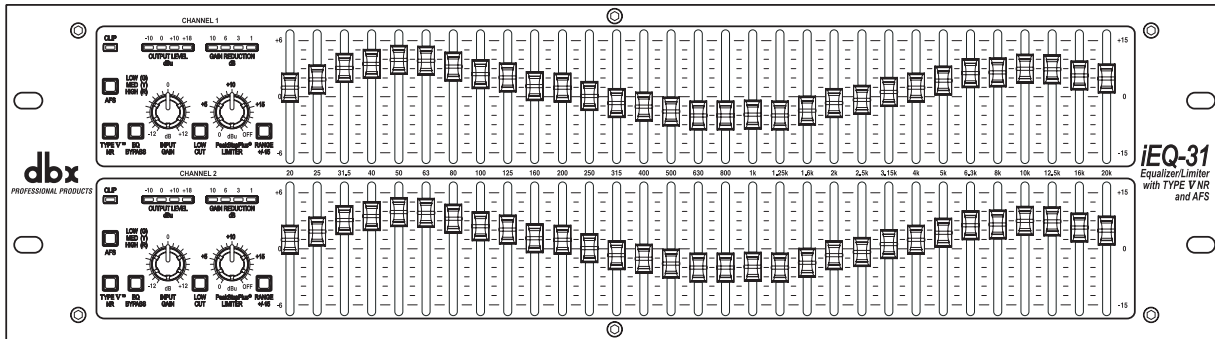

**Input Gain Control:** This control sets the signal level to the equalizer. It is capable of -12dB to +12dB of gain. Its effect is apparent by viewing the OUTPUT LEVEL BAR GRAPH.

**EQ Bypass:** This switch removes the graphic equalizer section from the signal path. The BYPASS switch does not, however, affect the INPUT GAIN, AFS, or LOW CUT filters. This button lights red when the EQ is in bypass mode

**Boost/Cut Range Selection Switch:** This switch selects which of the two boost/cut ranges the equalizer will use, either ±6dB or ±15dB. The button lights red when the ±15dB range is selected.

**Output Level Bar Graph:** These four LEDs indicate output level of the equalizer. It monitors the level at the output of the equalizer after all other processing, including the limiter.

**Clip LED:** This LED lights whenever any internal signal level reaches 1dB below clipping which may occur when any of the following happen: 1) the input signal is “hotter” than +20dBu, 2) excessive gain is applied by the input gain control, or 3) excessive boost is applied using the frequency sliders.

**Gain Reduction Meter:** These four LEDs indicate the amount of gain reduction being induced by the setting of the PeakStopPlus® LIMITER THRESHOLD control as the signal level from the graphic EQ section exceeds this limiter threshold setting.

**PeakStopPlus® Limiter Threshold Control:** This control engages the PeakStopPlus™ limiter. It sets the threshold level at which ∞:1 gain reduction will begin to occur. It is capable of a range of 0dBu through “OFF” (+20dBu). When the threshold control is set to “OFF”, the limiter is effectively disabled, and no gain reduction will occur.

**AFS™ (Advanced Feedback Suppression) Switch:** This control engages the AFS function of the iEQ 15 and 31. If AFS is Off, the filters are bypassed, and the algorithm is halted (the filters are not updated). If AFS is On, the filters are active. The AFS modes are as follows:

AFS Mode:	AFS Button LED Color:	Bandwidth:	Q:
Off	Off		
Music Low	Green	1/10 Octave	14.5
Music Medium	Yellow	1/20 Octave	29
Music High	Red	1/80 Octave	116

Lift times are set up at power-up:

- Off
- Short 10 Minutes
- Long 60 Minutes

The iEQ 15 and 31 offer the exclusive patent pending AFS (Advanced Feedback Suppression) feedback elimination module. The AFS uses Precision Frequency Detection and state-of-the-art processing to determine the exact portions of a given frequency of your feedback that need to be removed (instead of taking out large sections of your sound). For more detailed information regarding AFS, please visit the AFS white paper section at [www.dbxpro.com](http://www.dbxpro.com).

The AFS module of the iEQ 15 and 31 allow the user to optimize the elimination of feedback. In the past, graphic equalizers were used to eliminate feedback from a system. This was an acceptable method for eliminating feedback, but when this method was precision tested, the result clearly showed that a single 1/3 octave EQ slider was removing approximately half of the signal power. With the AFS, the module removes the feedback automatically and the proprietary, precision AFS filters remove only a fraction of the frequency spectrum. The following diagram shows AFS as opposed to competing, competitive feedback eliminators and conventional graphic EQs:

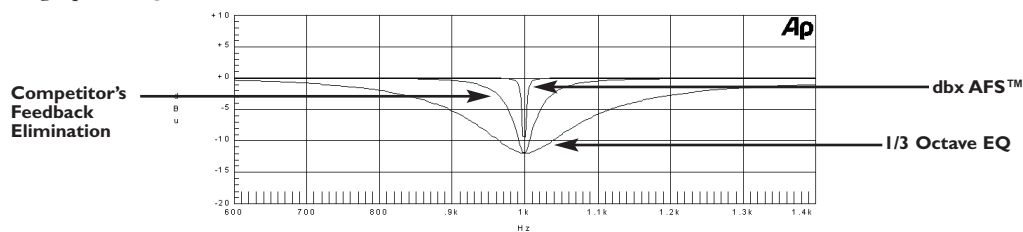

**dbx Type V™ Noise Reduction:** This button engages (when lit) the dbx Type V™ Noise Reduction circuit within the EQ. Typically, graphic equalizers raise the noise floor within the signal path, and dbx's proprietary Type V™ noise reduction will reduce the apparent noise floor through its simultaneous encode/decode process (shown below). The button lights when the dbx Type V™ Noise Reduction circuit is activated.

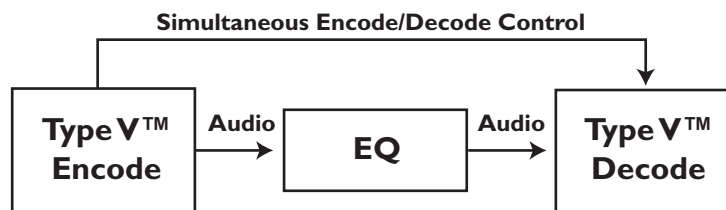

**Frequency Band Slider Controls:** Each one of these slider potentiometers will boost or cut at its noted frequency by  $\pm 6\text{dB}$  or  $\pm 15\text{dB}$ , depending upon the position of the BOOST/CUT RANGE switch. When all the sliders are in the center detented position the output of the equalizer is flat. The frequency band centers of the iEQ-31 are marked at 1/3rd of an octave intervals on ISO standard spacings, while the frequency band centers of the iEQ-15 are marked at 2/3rds of an octave intervals on ISO standard spacings.

**Low Cut Enable:** The LOW-CUT button inserts (when lit) or removes the 18dB/octave 40Hz Bessel low-cut filter from the signal path. When the LOW-CUT switch is pushed in, the LOW-CUT filter is IN the audio path.

**Basic Connection of the iEQ**

The iEQ Series Equalizers have balanced inputs and outputs that can be used with any balanced or unbalanced line-level device.

To connect the equalizer to your sound system refer to the following steps:

- Turn off all equipment before making connections.
- Mount equalizer in a standard-width rack.
  - Install the EQs in a rack with the rack screws provided. It can be mounted above or below anything that does not generate excessive heat. Ambient temperatures should not exceed 113° F (45°C) when equipment is in use. Although the unit's chassis is shielded against radio frequency and electromagnetic interference, extremely high fields of RF and EMI should be avoided.
- Make audio connections via XLR, 1/4" TRS jacks or Euroblock connectors according to application needs. All three types of connectors for the inputs and outputs can be used for balanced or unbalanced connections. The use of more than one connector at a time for the inputs could unbalance balanced lines, cause phase cancellation, short a conductor to ground, or cause damage to other equipment connected to the equalizer. More than one output may be used simultaneously as long as the combined parallel load is greater than 600Ω.
- Select the operating range with the boost/Cut range selection switch
  - Note: Be sure to reduce audio levels at the power amplifiers when changing the setting of this switch as it may generate an audible transient.
- Apply power to the equalizer. Connect the AC power cord to the AC power receptacle on the back of the equalizer. Route the AC power cord to a convenient power outlet away from audio lines. The unit may be turned on and off from the rear panel power switch or a master equipment power switch. Since the iEQ Series Equalizers consume a relatively small amount of power, the units may be left on continuously.

### Block diagram

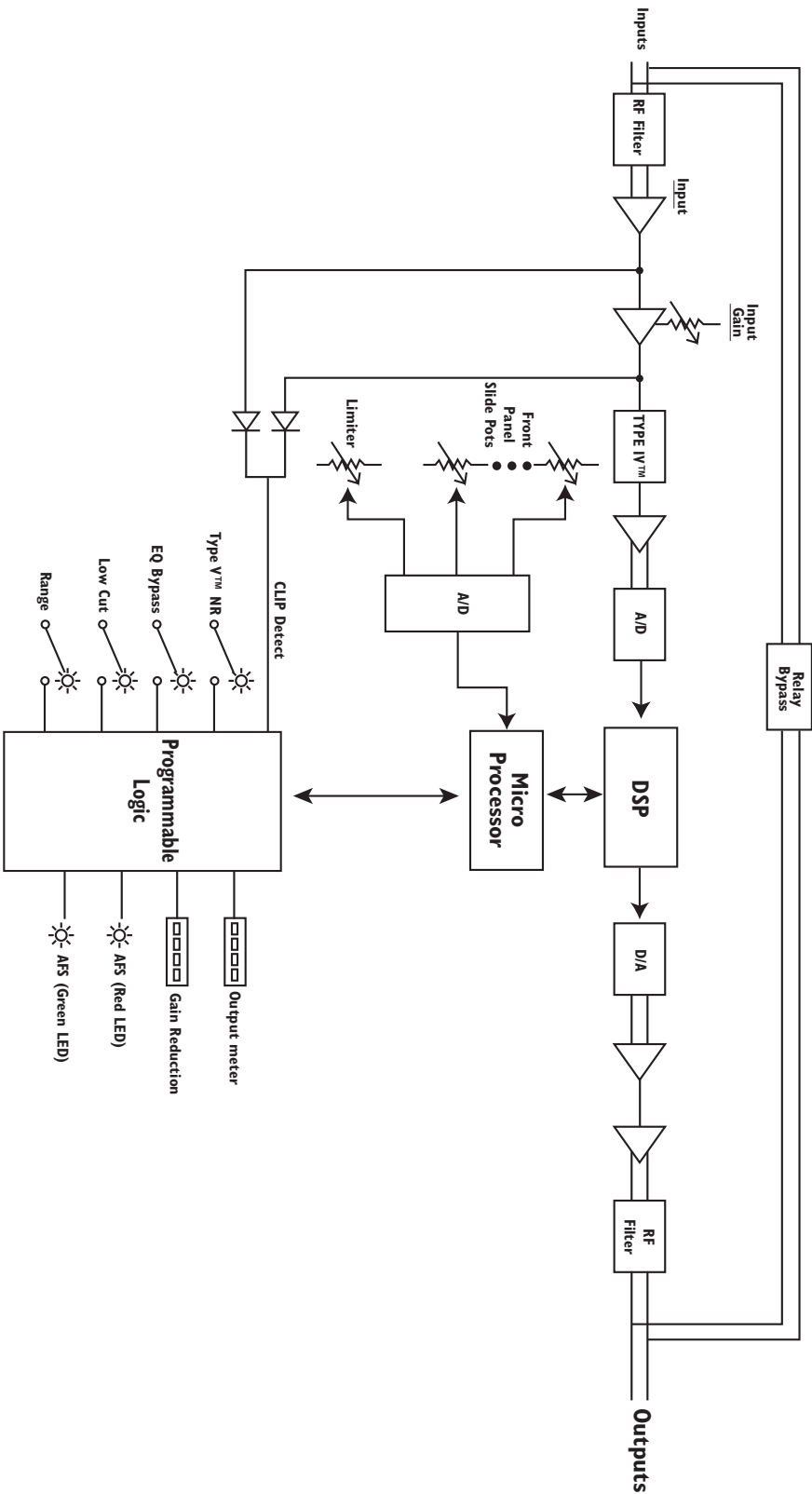

dbx iEQ 15 and 31 Graphic Equalizer  
Block Diagram

## Specifications

**Inputs**

Connectors:	1/4" TRS, female XLR (pin 2 hot), and Euroblock
Type:	Electronically balanced/unbalanced, RF filtered
Impedance:	Balanced 40k $\Omega$ , unbalanced 20k $\Omega$
Max Input Level:	+22dBu balanced or unbalanced
CMRR:	>40dB, typically >55dB at 1kHz

**Outputs**

Connectors:	1/4" TRS, male XLR (pin 2 hot), and Euroblock
Type:	Balanced/unbalanced, RF filtered
Impedance:	Balanced 120 $\Omega$ , unbalanced 60 $\Omega$
Max Output Level:	+20dBu balanced/unbalanced into 2k $\Omega$ or greater

**System Performance**

Frequency Response:	20Hz to 20kHz, +0.5/-0.25dB
Dynamic Range:	>113dB, "A" weighted
THD+Noise:	0.003% typical at +4dBu, 1kHz
Interchannel Crosstalk:	<-80dB, 20Hz to 20kHz
Noise Reduction:	Up to 10dB of dynamic broadband noise reduction
Digital Resolution:	24 bits
Sample Frequency:	48kHz
Latency:	2msec

**Function Switches**

AFS™:	Activates dbx AFS™ Advanced Feedback Suppression
TYPE V™ NR:	Activates dbx Type V™ Noise Reduction
EQ Bypass:	Bypasses the graphic equalizer section in the signal path
Low Cut:	Activates the 40Hz 18dB/octave Bessel high-pass filter Range
Range:	Selects either +/- 6dB or +/- 15dB slider boost/cut range

**Indicators**

Output Level:	4-LED bar graph (Green, Green, Yellow, Red) at -10, 0, +10, and +18dBu
Gain Reduction:	4-LED bar graph (all Red) at 0, 3, 6, and 10dB
Type V™ NR:	1 LED: yellow, green or red
EQ Bypass:	1 LED: red
Clip:	1 LED: red
Low Cut:	1 LED: red
+/-15dB:	1 LED: red

**Power Supply**

Operating Voltage:	120VAC 60Hz, 220-240VAC 50/60Hz
Power Consumption:	17 Watts
Mains Connection:	IEC receptacle

**Physical**

Dimensions:	
iEQ15:	3.5" H X 19" W X 7.9" D (8.9cm x 48.3cm x 20.1cm)
iEQ31:	5.25" H X 19" W X 7.9" D (13.4cm x 48.3cm x 20.1cm)
Dimensions (h x l x p):	
Weight:	
iEQ15:	7.5 lbs.
iEQ31:	9.25 lbs.
Shipping Weight:	
iEQ 15:	8.5 lbs.
iEQ 31:	10.25 lbs.

Note: Specifications subject to change.



## ***PROFESSIONAL PRODUCTS***

**H** A Harman International Company

**8760 South Sandy Pkwy.**

**Sandy, Utah 84070**

**Phone: (801) 568-7660**

**Fax: (801) 568-7662**

**Questions or comments?**

**E•mail us at: [customer@dbxpro.com](mailto:customer@dbxpro.com)**

**or visit our World Wide Web home page at:**

**[www.dbxpro.com](http://www.dbxpro.com)**