

dbx[®] *PROFESSIONAL PRODUCTS*

DriveRack[™]

Complete Equalization & Loudspeaker Management System

260



Featuring

JBL

 **CROWN**[®]

Custom Tunings

 A Harman International Company

User Manual

IMPORTANT SAFETY INSTRUCTIONS

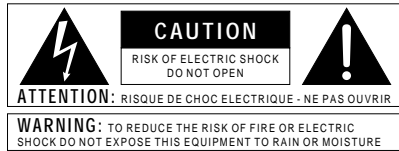

The symbols shown above are internationally accepted symbols that warn of potential hazards with electrical products. The lightning flash with arrowpoint in an equilateral triangle means that there are dangerous voltages present within the unit. The exclamation point in an equilateral triangle indicates that it is necessary for the user to refer to the owner's manual.

These symbols warn that there are no user serviceable parts inside the unit. Do not open the unit. Do not attempt to service the unit yourself. Refer all servicing to qualified personnel. Opening the chassis for any reason will void the manufacturer's warranty. Do not get the unit wet. If liquid is spilled on the unit, shut it off immediately and take it to a dealer for service. Disconnect the unit during storms to prevent damage.

SAFETY INSTRUCTIONS

NOTICE FOR CUSTOMERS IF YOUR UNIT IS EQUIPPED WITH A POWER CORD.

WARNING: THIS APPLIANCE MUST BE EARTHED.

The cores in the mains lead are coloured in accordance with the following code:

GREEN and YELLOW - Earth BLUE - Neutral BROWN - Live

As colours of the cores in the mains lead of this appliance may not correspond with the coloured markings identifying the terminals in your plug, proceed as follows:

- The core which is coloured green and yellow must be connected to the terminal in the plug marked with the letter E, or with the earth symbol, or coloured green, or green and yellow.
- The core which is coloured blue must be connected to the terminal marked N or coloured black.
- The core which is coloured brown must be connected to the terminal marked L or coloured red.

This equipment may require the use of a different line cord, attachment plug, or both, depending on the available power source at installation. If the attachment plug needs to be changed, refer servicing to qualified service personnel who should refer to the table below. The green/yellow wire shall be connected directly to the units chassis.

CONDUCTOR		WIRE COLOR	
		Normal	Alt
L	LIVE	BROWN	BLACK
N	NEUTRAL	BLUE	WHITE
E	EARTH GND	GREEN/YEL	GREEN

WARNING: If the ground is defeated, certain fault conditions in the unit or in the system to which it is connected can result in full line voltage between chassis and earth ground. Severe injury or death can then result if the chassis and earth ground are touched simultaneously.

WARNING FOR YOUR PROTECTION PLEASE READ THE FOLLOWING:

KEEP THESE INSTRUCTIONS

HEED ALL WARNINGS

FOLLOW ALL INSTRUCTIONS

DO NOT USE THIS APPARATUS NEAR WATER

CLEAN ONLY WITH A DRY CLOTH.

DO NOT BLOCK ANY OF THE VENTILATION OPENINGS. INSTALL IN ACCORDANCE WITH THE MANUFACTURER'S INSTRUCTIONS.

DO NOT INSTALL NEAR ANY HEAT SOURCES SUCH AS RADIATORS, HEAT REGISTERS, STOVES, OR OTHER APPARATUS (INCLUDING AMPLIFIERS) THAT PRODUCE HEAT.

ONLY USE ATTACHMENTS/ACCESSORIES SPECIFIED BY THE MANUFACTURER.

UNPLUG THIS APPARATUS DURING LIGHTNING STORMS OR WHEN UNUSED FOR LONG PERIODS OF TIME.

Do not defeat the safety purpose of the polarized or grounding-type plug. A polarized plug has two blades with one wider than the other. A grounding type plug has two blades and a third grounding prong. The wide blade or third prong are provided for your safety. If the provided plug does not fit your outlet, consult an electrician for replacement of the obsolete outlet.

Protect the power cord from being walked on or pinched particularly at plugs, convenience receptacles, and the point where they exit from the apparatus.

Use only with the cart stand, tripod bracket, or table specified by the manufacture, or sold with the apparatus. When a cart is used, use caution when moving the cart/apparatus combination to avoid injury from tip-over.



Refer all servicing to qualified service personnel. Servicing is required when the apparatus has been damaged in any way, such as power-supply cord or plug is damaged, liquid has been spilled or objects have fallen into the apparatus, the apparatus has been exposed to rain or moisture, does not operate normally, or has been dropped.

POWER ON/OFF SWITCH: For products provided with a power switch, the power switch DOES NOT break the connection from the mains.

MAINS DISCONNECT: The plug shall remain readily operable. For rack-mount or installation where plug is not accessible, an all-pole mains switch with a contact separation of at least 3 mm in each pole shall be incorporated into the electrical installation of the rack or building.

FOR UNITS EQUIPPED WITH EXTERNALLY ACCESSIBLE FUSE RECEPTACLE: Replace fuse with same type and rating only.

MULTIPLE-INPUT VOLTAGE: This equipment may require the use of a different line cord, attachment plug, or both, depending on the available power source at installation. Connect this equipment only to the power source indicated on the equipment rear panel. To reduce the risk of fire or electric shock, refer servicing to qualified service personnel or equivalent.

This Equipment is intended for rack mount use only.

IMPORTANT SAFETY INSTRUCTIONS

ELECTROMAGNETIC COMPATIBILITY

This unit conforms to the Product Specifications noted on the **Declaration of Conformity**. Operation is subject to the following two conditions:

- this device may not cause harmful interference, and
- this device must accept any interference received, including interference that may cause undesired operation.

Operation of this unit within significant electromagnetic fields should be avoided.

- use only shielded interconnecting cables.

U.K. MAINS PLUG WARNING

A molded mains plug that has been cut off from the cord is unsafe. Discard the mains plug at a suitable disposal facility. **NEVER UNDER ANY CIRCUMSTANCES SHOULD YOU INSERT A DAMAGED OR CUT MAINS PLUG INTO A 13 AMP POWER SOCKET.** Do not use the mains plug without the fuse cover in place. Replacement fuse covers can be obtained from your local retailer. Replacement fuses are 13 amps and **MUST** be ASTA approved to BS1362.

DECLARATION OF CONFORMITY

Manufacturer's Name: dbx Professional Products
Manufacturer's Address: 8760 S. Sandy Parkway
Sandy, Utah 84070, USA

declares that the product:

Product name: dbx 260
Note: Product name may be suffixed by the EU.

Product option: None

conforms to the following Product Specifications:

Safety: IEC 60065 (1998)

EMC: EN 55013 (1990)
EN 55020 (1991)

Supplementary Information:

The product herewith complies with the requirements of the Low Voltage Directive 72/23/EEC and the EMC Directive 89/336/EEC as amended by Directive 93/68/EEC.

Vice-President of Engineering
8760 S. Sandy Parkway
Sandy, Utah 84070, USA
Date: September 19,2002

European Contact:

Your local dbx Sales and Service
Office or
Harman Music Group
8760 South Sandy Parkway
Sandy, Utah 84070 USA
Ph: (801) 566-8800
Fax: (801) 568-7583

Introduction

0.1 Defining the 260 DriveRack	ii
0.2 Service Contact Info	iii
0.3 Warranty	iv

Section 1 - Getting Started

1.1 Rear Panel Connections	2
1.2 Front Panel	2
1.3 Quick Start	4

Section 2 - Editing Functions

2.1 Basic Navigation Modes	14
2.2 Effect Button Array Overview	14
2.3 Navigating the Pre-EQ Section	15
2.4 Navigating the Crossover Section	15
2.5 Navigating the Other Section	16
2.6 Navigating the Dynamics Section	16
2.7 Navigating the Delay Section	17
2.8 Navigating the Utility/Meters Section	17
2.9 Navigating the Wizard Section	18
2.10 Navigating the I/O Section	18

Section 3 - Configuration Functions

3.1 Program Definition	20
3.2 Navigating Factory Programs	20
3.3 Editing Factory Programs	21
3.4 Saving Factory Program Changes	22
3.5 Creating a User Configuration	23
3.6 Saving Configuration Changes	26

Section 4 - Detailed Parameters

4.1 Pre-Crossover EQ (31 Band Graphic) or (9-Band Parametric)	28
4.2 Feedback Eliminator (AFS)	29
4.3 Subharmonic Synthesizer	30
4.4 Noise Gate	31
4.5 Automatic Gain Control (AGC)	32
4.6 Notch Filters	33
4.7 Crossover	33

4.8 Post-Crossover PEQ	33
4.9 Compressor/Limiter	34
4.10 Alignment Delay	37
4.11 Input Routing	37
4.12 Output	38

Section 5 - Utilities/Meters

5.1.1 LCD Contrast/Auto EQ Plot	40
5.1.2 PUP Program/Mute	40
5.1.3 ZC Setup	41
5.1.4 Security	42
5.1.5 Program List/Program change	45
5.1.6 Output Jumper switches	46
5.2.1 Meters	47

Section 6 - Remote Control

6.1.1 PC GUI Installation	50
System Requirements	50
Install	50
Basic Operation	50
Cable specs	52
6.2.1 ZC-Zone Controllers	53

Section 7 - Application Guide

7.1 Mono 4-Way w/ 2 Aux Zones	58
7.2 Stereo Tri-Amp	59
7.3 Stereo w/ 4 Aux Zones	60
7.4 Stereo Bi-Amp w/ Dual Delays	61

Appendix

A.1 Factory Reset	64
A.2 Power up Quick Key Options	64
A.3 Specifications	65
A.4 Auto EQ Optimization	66
A.5 Crossover Diagrams	67
A.6 Prog List/Speaker Tunings/ Power Amp Tunings	68
A.7 Block Diagram	69
A.8 Input and Output Section Diagrams	70
A.9 Gain Level Jumpers	71
A.10 System Setup and Gain Structure	71

DriveRack™

INTRODUCTION

INTRO
CUSTOMER SERVICE INFO
Defining the
DriveRack
WARRANTY INFO



dbx®
PROFESSIONAL PRODUCTS

INTRODUCTION

Congratulations on your purchase of the dbx® DriveRack™ 260 Complete Equalization and Loudspeaker Management System! For over 30 years, dbx has been the industry leader in dynamics processing. With the DriveRack 260, dbx Professional Products has redefined the standard by which all other loudspeaker management processors will be compared.

The DriveRack 260 continues the legacy of DriveRack™ family. The DriveRack 260 was designed with the purpose and vision of providing state-of-the-art signal processing, while utilizing a simple and intuitive user interface. For more information, please visit: www.driverack.com or www.dbxpro.com.

This manual will be your guide to understanding the full functionality of the powerful DriveRack 260. By combining the different components, the configuration possibilities are limitless. After you have become familiar with the unit, we encourage you to experiment and find the most effective and efficient way to run your system by utilizing the powerful processing of the DriveRack 260.

0.1 Defining the 260 DriveRack System

The dbx 260 DriveRack is the most effective way to manage all aspects of post mixer processing and signal routing. The 260 DriveRack essentially becomes the only device that you will need between the mixer and the power amps. The following are just some of the features of the 260 and 260 DriveRack™ units.

260 DriveRack™ features:

- ***Advanced Feedback Suppression™***
- ***2.7 Seconds of Alignment and Zone Delay***
- ***RS-232 PC GUI control***
- ***Classic dbx® Compression and Limiting***
- ***Graphic and Parametric EQ***
- ***Independent Input and Output Processing***
- ***Auto-EQ Function***
- ***Full Bandpass, Crossover, and Routing Configurations***
- ***Auto Gain Control***
- ***Pink Noise Generator and full-time RTA***
- ***Setup Wizard with JBL® and Crown® Components***
- ***Security Lockout***
- ***Wall Panel Control Inputs***

In addition to the amazing menu of processors available, the 260 also affords you the luxury of utilizing dbx Zone-Controller series wall-mounted control panels that will allow you to remotely control various parameters of the 260. The ZC-1 offers remote programmable Volume control to any installation using the DriveRack™ 260. The ZC-2 provides programmable Volume and Mute control. Both the ZC-1 and ZC-2 can be programmed for up to six outputs of the DriveRack™ 260. The ZC-3 allows Program Selection on the 260. The ZC-4 also offers Program Selection via Contact Closure inputs for Room Combining applications. Up to six Zone Controllers can be used with a single DriveRack™ 260, and can either be wired in series or parallel. The ZC-BOB was created to accommodate “home-run” or parallel wiring to the unit. With a maximum length of 5,000 ft., the Zone Controllers offer a simple way to create a simple yet elegant solution to many installation applications.



0.2 Service Contact Info

If you require technical support, contact dbx Customer Service. Be prepared to accurately describe the problem. Know the serial number of your unit - this is printed on a sticker attached to the top panel. If you have not already taken the time to fill out your warranty registration card and send it in, please do so now.

Before you return a product to the factory for service, we recommend you refer to the manual. Make sure you have correctly followed installation steps and operation procedures. If you are still unable to solve a problem, contact our Customer Service Department at (801) 568-7660 for consultation. If you need to return a product to the factory for service, you **MUST** contact Customer Service to obtain a Return Authorization Number.

No returned products will be accepted at the factory without a Return Authorization Number.

Please refer to the Warranty information on the following page, which extends to the first end-user. After expiration of the warranty, a reasonable charge will be made for parts, labor, and packing if you choose to use the factory service facility. In all cases, you are responsible for transportation charges to the factory. dbx will pay return shipping if the unit is still under warranty.

Use the original packing material if it is available. Mark the package with the name of the shipper and with these words in red: DELICATE INSTRUMENT, FRAGILE! Insure the package properly. Ship prepaid, not collect. Do not ship parcel post.

0.3 Warranty

This warranty is valid only for the original purchaser and only in the United States.

1. The warranty registration card that accompanies this product must be mailed within 30 days after purchase date to validate this warranty. Proof-of-purchase is considered to be the burden of the consumer.
2. dbx warrants this product, when bought and used solely within the U.S., to be free from defects in materials and workmanship under normal use and service.
3. dbx liability under this warranty is limited to repairing or, at our discretion, replacing defective materials that show evidence of defect, provided the product is returned to dbx WITH RETURN AUTHORIZATION from the factory, where all parts and labor will be covered up to a period of two years. A Return Authorization number must be obtained from dbx by telephone. The company shall not be liable for any consequential damage as a result of the product's use in any circuit or assembly.
4. dbx reserves the right to make changes in design or make additions to or improvements upon this product without incurring any obligation to install the same additions or improvements on products previously manufactured.
5. The foregoing is in lieu of all other warranties, expressed or implied, and dbx neither assumes nor authorizes any person to assume on its behalf any obligation or liability in connection with the sale of this product. In no event shall dbx or its dealers be liable for special or consequential damages or from any delay in the performance of this warranty due to causes beyond their control.

DriveRack™

Section 1

Getting Started



dbx[®]
PROFESSIONAL PRODUCTS

1.1 Rear Panel Connections



IEC Power Cord Receptacle

The DriveRack 260 comes with a power supply that will accept voltages ranging from 100V-120V at frequencies from 50Hz-60Hz. An IEC cord is included. EU version accepts 220V-240V at frequencies from 50Hz-60Hz.

Power Switch

The Power Switch turns the DriveRack 260 on and off. **Note:** dbx Professional Products recommends that power amplifiers connected to the DriveRack 260, should be powered down prior to cycling the power on the DriveRack 260.

PC Connection

This DB-9 type connection is used to send and receive information to and from the GUI interface.

RS485 Zone Control Input (RJ-45 connector type)

This input connection is used to send information and power to the ZC wall controllers.

Outputs 1-6

The output section of the DriveRack 260 offers six electronically balanced XLR connectors.

Inputs 1-2

The input section of the DriveRack 260 offers two electronically balanced XLR connectors.

Ground Lift Switch

The ground lift switch lifts the pin 1 chassis ground of both input XLR connectors.

RTA Input Jack

This balanced XLR input is used for the connection of an RTA microphone, which allows the user to “Pink” and optimize the EQ settings of any room through the use of the Auto EQ in the Wizard setup assistant.

1.2 Front Panel



LCD Display

The backlit LCD display of the DriveRack 260 provides the user with all of the vital processing information of the DriveRack 260 including: signal routing, effect block editing and Wizard Setup functions. The display will also notify the user if any internal clipping is taking place within the unit by displaying "CLIP" in the display.

Data Wheel

The Data wheel of the DriveRack 260 is used to scroll through the program menu, load programs, select parameters and edit parameter values.

Function Buttons

The function buttons of the DriveRack 260 allow direct access to all editing and navigating functions of the DriveRack 260. The functions of the aforementioned buttons are as follows:

- <PREV PG> - is used to navigate back through the various pages of any module block.
- <NEXT PG> - is used to navigate forward through the various pages of any module block.
- <EQ> - is used to move to the EQ modules. Successive presses will move you through the EQ modules in the input section and through EQ modules located in the output section.
- <XOVER> - is used to move to the Crossover module.
- <OTHER> - This button is used to move to the insert module section module which can include modules such as: Notch Filters, Subharmonic Synthesizer and the Advanced Feedback Suppression (AFS) modules.
- <DYNAMICS> - is used to move to the Compressor, Compressor, Gate, Auto Gain Control (AGC), or Limiter modules.
- <DELAY> - is used to move to the Delay modules.
- <I/O> - is used to move to select each one of the 2 input and 6 output modules.
- <PROGRAM> (CONFIG)- is used to enter program mode. When pressed and held, the 260 will enter configuration mode.
- <UTILITY> (METER)- is used to access the the Utility menu. When pressed and held, the 260 will enter METER mode.
- <STORE> (DELETE)- is used to store any program changes. When pressed and held, the 260 will enter the PROGRAM DELETE module.
- <RTA> (WIZARD)- is used to enter the RTA module. When pressed and held, the 260 will enter the Wizard section which includes: SYSTEM SETUP, AFS and AUTO EQ WIZARD.

Input Meters

The DriveRack 260 provides the user with two independent, six segment Lightpipe™ input meters that range from -30 to +22 dBu. These meters monitor the signal level right after the input module.

Threshold Meters

The threshold meters indicate that the threshold level has been exceeded within the Limiter and Auto Gain Control sections, and gain reduction may be taking place within the specific output channel.

Output Mutes

The six output mute buttons are used for independently muting each output on all six outputs of the DriveRack 260.

Output Meters

The DriveRack 260 provides the user with six independent six-segment Lightpipe™ output meters that range from -30 to +22 dBu.

1.3 Quick Start

For those of you that wish to jump right in, the following information has been provided to act as a quick start guide for optimizing performance of the DriveRack 260.

Signal Path Block Diagram

The following diagram shows the logical and intuitive signal path of the input, effect modules, and output of the DriveRack 260.

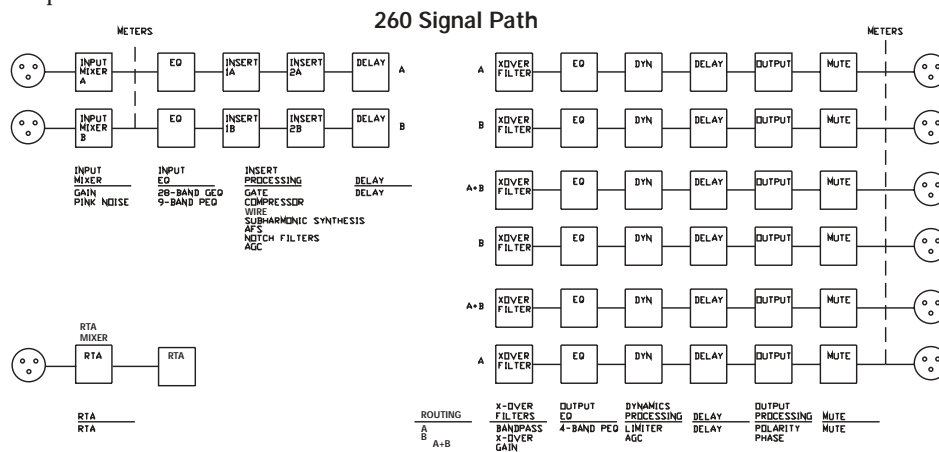

Connections

- When setting up the DriveRack 260, make connections as follows:
- Always make connections prior to applying power to the unit.
- Connect the output from the sending device (mixer) to either of the two XLR inputs connectors shown below.
- Make output connections from any one of the six output XLR connectors shown below to the input of the selected power amps.



- Connect the selected RTA microphone to the RTA XLR input.
- **IMPORTANT**- It is recommended that the power amps are turned off prior to cycling power to the Driverack 260. Always make sure that your power amps are the last item turned on and the first turned off.

Once all of the connections have been made and the unit is powered up, you can navigate through the entire signal path of the DriveRack 260 from the front panel of the unit. The display provides you with a clear and concise overview of each aspect

of the signal path from the input to the output section.



The features of the front panel of the DriveRack 260 are as follows from left to right.
LCD Display- All operational information of the 260 DriveRack is displayed here. The display will also notify the user if any internal clipping is taking place within the unit. The following message will appear: **CLIP**.
Data Wheel - The data wheel is used to scroll through the program menu of the 260 DriveRack. The Data Wheel is also used to perform editing functions to effects and utility menu features.
Button Array - Operational editing is done using this 12 button array. A complete description of each button's functionality is listed below.
Input meters- These two 6-segment LED meters monitor the input level of the 260 DriveRack directly after the input mixer.
Output mutes - These six mute buttons are used to mute the output signal of the 260 DriveRack.
Output meters - These six 6-segment meters monitor the output levels of the 260 DriveRack directly after the output gain stage.
Threshold meters - These six 1-segment meters show that threshold level of the output dynamics has been exceeded.

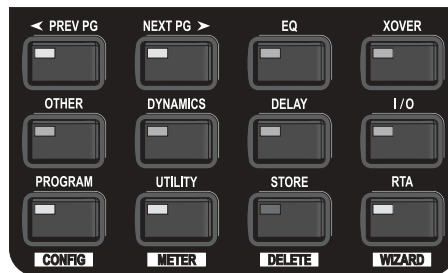

260 DriveRack Wizard

Now that you have made all of your audio connections and have made yourself familiar with the front-panel navigation of the unit, you can easily optimize your system through the use of the 260 DriveRack Wizard. This feature of the 260 DriveRack allows for quick and accurate venue setups. The menu section of the Wizard offers System setup, Auto EQ and AFS (Advanced Feedback Suppression). The following will walk you through your venue setup.

- From program mode, press and hold the <RTA> /Wizard button and the display will appear as follows:



System Setup

- The arrow will indicate the selected Wizard setup. To select any one of the three options, rotate the <DATA> wheel. If you are performing the System setup, press either the <NEXT PG> button or the <DATA> wheel and the display will appear as follows:

```
Input Setup
Select Input as MONO
or STEREO.
▶STEREO
```

- Simply rotate the <DATA> wheel to select either a Mono or Stereo input configuration. Once you have selected your input option, press the <NEXT PG> button and the display will appear as follows:

```
EQ Setup
Select EQ as GEQ
or PEQ
▶PEQ
```

- Simply rotate the <DATA> wheel to select either a Graphic or Parametric EQ. Once you have selected your EQ option, press the <NEXT PG> button and the display will appear as follows:

```
Insert 1 Setup
Select Insert 1
effect.
▶Compressor
```

- Rotate the <Data> wheel to select any one of the numerous Insert modules available. Once you have selected your Insert 1 module option, press the <NEXT PG> button and the display will appear as follows:

```
Insert 2 Setup
Select Insert 2
effect.
▶AFS
```

- Rotate the <Data> wheel to select any one of the numerous Insert modules available. Once you have selected your Insert 1 module option, press the <NEXT PG> button and the display will appear as follows:

```
Main Speaker
Select Main PA
JBL SRX
▶SR4702X Passive
```



- Rotate the <Data> wheel to select any one of the numerous custom-tuned MAIN speaker options available. If the speaker being used is not specified in the menu, select CUSTOM. Once you have selected your Main speaker option, press the <NEXT PG> button and the display will appear as follows:



- Rotate the <Data> wheel to select any one of the numerous custom-tuned SUB speaker options available. Once you have selected your SUB speaker option, press the <NEXT PG> button and the display will appear as follows:



- You are now prompted to select a power amp by rotating the <DATA> wheel to select any one of the numerous custom-tuned Amplifier options available. Note that the top line of the display will either read High, Mid or Low depending on your selected speaker setup selections. Once you have selected your Amp tuning option (depending on the amp type), you will select the specified amplifier sensitivity setting if applicable.



- Rotate the <DATA> wheel to select the amplifier manufacturer's specified amplifier sensitivity setting. Once set, press the <NEXT PG> button, and you will now be given the option of optimizing your amp levels with the 260 DriveRack for . The page will appear something like this:

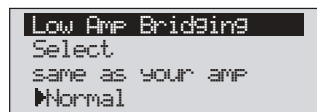

- You will now rotate the <DATA> wheel to match the same setting as your amplifier of choice. Note that based on your amp selection, the 260 DriveRack will initially display the recommended setting of that particular amp for obtaining maximum headroom. This is done to match unity gain from the 260 DriveRack and your amplifier. Note that if Sub Speakers are included in the speaker selection, you will be asked if the sub woofer is bridged or mono. For more information regarding Amplifier gain settings, please refer to the *System Setup and Gain Structure* information located in the appendix section.

Note that you will perform the previous Amplifier settings for Mid and Low if your application requires Mid and Low amplifiers.

- Once you have completed your amp level settings, you will press the <NEXT PG> button, where you will be asked to select a bridged or normal setting for your low amp (if used). The display will appear as follows:
- Once you have made a bridged or mono selection, press the <NEXT PG> where the unit will prompt <DATA> wheel to load your new settings. If you do not wish to load the settings either press the <PROGRAM> button or use the <PREV PG> button to re-edit your settings. By using your selections, the DriveRack™ will automatically generate a new program and speaker selection which are used to choose the correct crossover type, parameters, speaker compensation EQ and delay are also adjusted by the speaker selection. Amplifier parameters are used to set the limiters to stop amplifier clipping and balance out the crossover levels. You may find that you want to re-adjust the crossover levels based on your taste and type of music.

Auto EQ WIZARD

- Once you have custom-tailored your system setup, you can now proceed to EQ your system. The Auto EQ Wizard automatically adjusts the response of the system by producing pink noise and adjusting the Graphic EQ until the RTA matches a selected response. From the 260 DriveRack Wizard menu, rotate the <DATA> wheel until the display appears as follows:



- Either press the <NEXT PG> button or rotate the <DATA> wheel and the display will read:

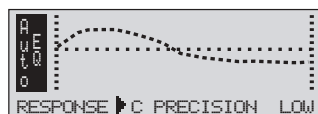

- You can now select any one of the several different Frequency responses for the Auto EQ. The options are: Flat (0), and Response A-D, and Low, Medium and High Precision. Once you have selected your desired EQ Frequency response, press the <NEXT PG> button and the display will appear as follows:



- You will now proceed to "Pink" the room by adjusting the Pink level. The range of bar graph is -30dBu to +20dBu. Connect an RTA-specific microphone to the rear-panel RTA mic input.

to. Be certain to raise the pink noise level to the level to be used during the performance. Once the Pink level has been adjusted to the desired volume. The mic level indicator will register the signal level. Press the **<NEXT PG>** button and the Auto EQ sequence will begin. The display will either show the graphic EQ or the RTA. Rotating the **<DATA>** wheel clockwise and counter clockwise will toggle between the two modes. You can also select either mode to default to in the Utility menu. Regardless, the display will appear something like this:



- At this point, the 260 DriveRack will automatically EQ the room. If you are using independent left and right graphic EQs, you will auto EQ each side independently. If you are using a stereo-linked EQ, both sides will be EQ'd simultaneously. Auto EQ can be aborted at any point in the process by pressing the **<NEXT PG>** button. Upon completion of the Auto EQ Wizard, you can return to program mode by releasing the **<RTA Input>** button and pressing the **<PROGRAM>** button.

For more information regarding the Auto EQ section, please refer to the Auto EQ Optimization Tips information located in the Appendix section.

AFS

- The 260 DriveRack also offers its exclusive AFS (Advanced Feedback Suppression) module which is located within the INSERT module section of select or user-created configurations. This unique feature now makes unwanted feedback in a PA system a thing of the past. The AFS Wizard will lead you through the setup of of the fixed filters of the AFS module. The fixed filter mode is designed to place notch filters as you introduce feedback by opening up your mics and slowly increasing the gain. Because the fixed mode is sensitive, it is important not to present an external music source such as CD player or other audio signal into the system. From the Wizard menu, rotate the **<DATA>** wheel until the display appears as follows:



- Press the **<NEXT PG>** button and the display will read:

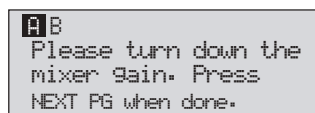

- Once the gain level of the mixer has been turned down, press the **<NEXT PG>** but-

ton and the display will read:

```

A B  F F F F F L L L L L L
Select total number
of AFS filters. ▶ 12
  
```

- You will now use the <DATA> wheel to select the number of fixed filters. This will range from values 0-12. The total number of filters will stay at 12, and the number of live filters will be = Total Num Filters - Num Fixed. Live and Fixed filter types differ in that FIXED mode filters are automatically assigned to a frequency creating feedback, thus remaining at that frequency until cleared by the user. In LIVE mode, live filters automatically detect and remove feedback frequencies in the presence of audio (music or speech). When all of the live filters have been used, they begin to round robin. Essentially this means that the first filter set is replaced where a new feedback is detected and notched out. This mode is useful because feedback frequencies may change as the microphone is moved, and/or as the characteristics of the venue change.

```

A B  F F F F F L L L L L L
Select number
of fixed filters. ▶ 6
  
```

- At this page, you will now select the number of fixed filter. Once the desired fixed number of filters has been selected, press the <NEXT PG> button and the display will read:

The Fixed/Live filter usage will be indicated at the bottom of each page of the feedback elimination effect. 'F' indicates an available fixed filter, and 'L' indicates an available live filter. A blocked out F or L indicates a filter that is set, or in use. Once the desired number has been selected, press the <NEXT PG> and the display will read:

```

A B
Select fixed type
▶ Speech
  
```

- These types pertain to the Q, sensitivity, and algorithm type. The filter is established by using the formula: $Q = \text{Freq} / \text{Bandwidth}$. This means that a higher Q will produce a filter that is more narrow. Values are: Speech (Bandwidth = 1/5 octave and $Q=7.25$) Music Low (Narrow notch filter, Bandwidth = 1/10 octave and $Q=14.5$), Music Medium (Very Narrow notch filter, Bandwidth = 1/20 octave and $Q=29$) Music High (Ultra Narrow notch filter, Bandwidth = 1/80 octave and $Q=116$). To guarantee that feedback is suppressed at lower frequencies, the AFS may place wider notch filters at these lower frequencies (below 700 Hz). Once the desired fixed type has been selected, press the <NEXT PG> button and the display will read:

```
AB FFFFFFFLLLLL
Slowly Increase the
mixer gain to
desired level.
```

- You are now prompted to raise the output gain of the mixer to the level of the performance. At this point, mics should be open (on) and you should slowly increase the mixer gain. Once the desired level has been set and all of the fixed filters have been assigned, the unit will automatically move you to the page that indicates the fixed filter setup has been completed. If you have reached the performance level setting and all of the fixed filters have not been used, you may want to return to the page that selects the number of fixed filters and re-adjust the number of fixed in order to provide you with additional live filters. Regardless, once you have completed the setup, the display will read:

```
AB FFFFFFFLLLLL
Fixed filter setup
done for Channel A.
In LIVE mode.
```

- To return to program mode, simply press the <PROGRAM> or <NEXT PG> button. For more information regarding feedback elimination, please see the AFS parameters of the Detailed parameters section.

EDITING FUNCTIONS



Editing Functions

2.1 Basic Navigation Modes

Navigational aspects of the 260 DriveRack is simple and as follows. **1. FX buttons** - This array of 12 FX buttons is your primary mode of directly accessing any effect module. **2. NEXTPG & PREVPG** page buttons - Successive presses of the **NEXTPG** or **PREVPG** page buttons will move the user from one page to the next in an effect block. **3. Data Wheel** - The Data Wheel is used to move through the program menu of the 260 DriveRack. The Data wheel is also used to change the values of the selected parameter by simply rotating the wheel. Pressing the Data wheel will toggle between the available parameters on any selected page of the currently selected effect module.

2.2 Effect Button Array Overview



PREVIOUS PAGE - Moves to the previous page in the currently selected effect menu.



NEXT PAGE - Moves to the next page in the currently selected effect menu.



EQ - Selects the EQ effect menu. This is the EQ section located prior to the crossover section. Successive presses will rotate through the various pre-crossover 28 band EQ and Post-xover PEQ section modules.



XOVER - Selects the Crossover section.



OTHER - This button is used to move to the module insert section module which includes the Notch filter, Subharmonic Synthesizer, AFS (Advanced Feedback Suppression) and Wire (no parameters) modules.



DYNAMICS - Selects the Dynamics effect sections. Successive presses will move from the Compressor, Gate and AGC (pre-xover) to the AGC and Limiter (post-xover).



DELAY - Selects the Alignment Delay effect module. successive presses will rotate through the Pre and post Delay modules.



I/O - Selects the input and output parameter editing section for all inputs and outputs. Successive presses will move through each input and output.



PROGRAM (Config) - This button is used to enter the Program screen from any sub section within the unit when pressed. When pressed and held, you will enter Config mode.



UTILITY(Meter) - Selects the Utility menu of the 260 DriveRack. When pressed and held, the 260 will enter METER mode.



STORE(Delete) - The store button is used to store program edits. When pressed and held, the 260 will enter the PROGRAM DELETE module.



RTA (Wizard) - This enters the RTA mode, or when held, enters the 260 DriveRack Wizard setup menu which includes: System Setup, Auto EQ setup and AFS Wizard.

2.3 Navigating the EQ Section (28-GEQ and PEQ)

To edit the parameters of the EQs used in a selected program, simply use the following procedure. From program mode, press the EQ button to reach the EQ module to be edited. Successive presses of the EQ button will move through each channel. Navigate through the Pages of the selected EQ section by depressing "Next Page" or "Prev Page" successively until arriving at the desired Page.

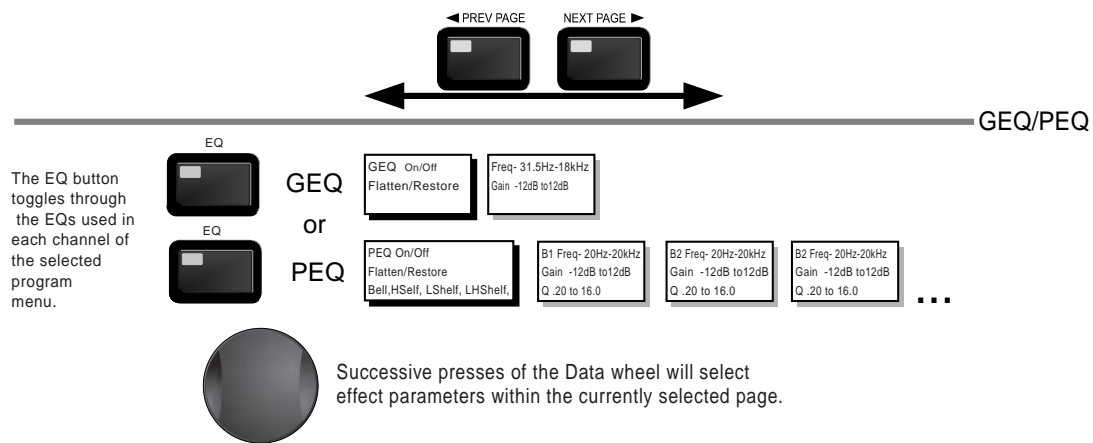

2.4 Navigating the XOVER Section

To edit the parameters of the Crossover used in a selected program, simply use the following procedure. From program mode, press the X-OVER button. Once you have reached the Crossover module, Navigate through the Pages of the selected Crossover module by pressing the "Next Page" or "Prev Page" buttons successively until arriving at the desired Page.

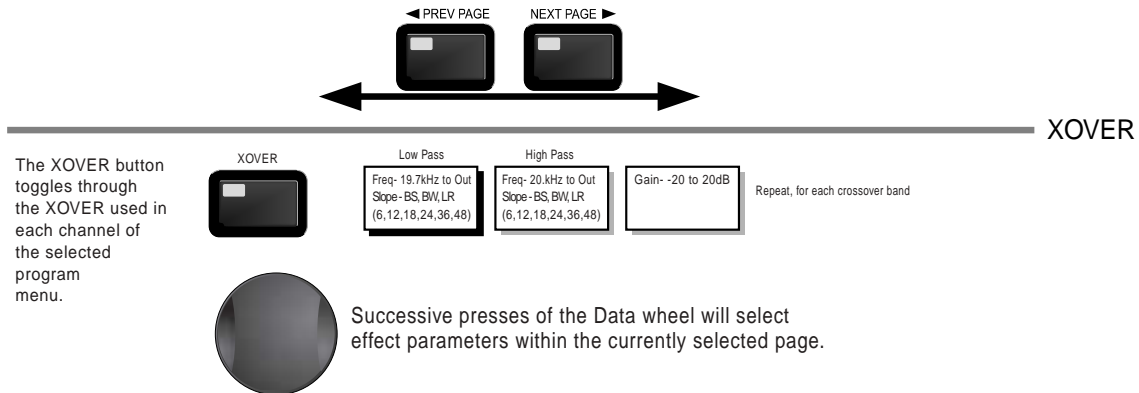

2.5 Navigating the Other Section

From program mode, press the Other button. Successive presses of the Other button will move you to each of the various insert modules available. Pressing the Data Wheel will select the effect parameter to be edited.

The diagram shows the 'OTHER' section interface. At the top, there are navigation buttons: '<PREV PG', 'NEXT PG>', and 'OTHER'. Below these are three 'OTHER' buttons, each corresponding to a different effect module. The first module is 'Subharmonic Synthesizer' with parameters: Subharmonic - On/Off, Subharmonics % 0-100, 24-36Hz Level - 24-36Hz, and 36-56Hz Level - 36-56Hz. The second module is 'Advanced Feedback Suppression (AFS)' with parameters: AFS On/Off, AFS Clear, Mode - Fixed/Live, Type- Speech, Low, Med and High, Number of filters 0-12, Number of filters fixed 0-12, and Live filter Lift - On/Off, Lift After - 0-60. The third module is 'Notch Filter' with parameters: Notch- On - Off, Flatten/Restore, Freq 1-6, 19.7Hz-20.2kHz, Gain-, -36dB - +6dB, and Q-, 16,32,64,128.

The NEXT and PREV buttons scroll through the pages of selected module.



Successive presses of the Data wheel will select effect parameters within the currently selected page.

2.6 Navigating the Dynamics Section

From program mode, press the comp/limiter button to move to either the Dynamics module. Once you have reached the Dynamics module, successive presses of Dynamics button will move through each channel that utilizes either a Compressor (pre Crossover) or Limiter (post-crossover) module. Navigate through the Pages of the selected compressor or Limiter module by pressing the "Next Page" or "Prev Page" buttons successively until you arrive at the desired Page.

The diagram shows the 'DYNAMICS' section interface. At the top, there are navigation buttons: '<PREV PAGE', 'NEXT PAGE', and 'DYNAMICS'. Below these are four 'DYNAMICS' buttons, each corresponding to a different effect module. The first module is 'COMP' with parameters: Comp On/Off, Auto On/Off, Over Easy Off, 1-10, Threshold -40 to -20dB, Ratio 1:1 to ∞:1, Gain -20 to 20dB, Attack 0.1 to 200ms, Hold 30 to 200ms, and Release 360 to 5.0dB/s. The second module is 'GATE' with parameters: Gate On/Off, Ratio 1:1 to ∞:1, Threshold -50-22dB, Attack 0.1 to 200ms, Hold 30 to 200ms, Release 360 to 5.0dB/s, and Max Attenuation 0 to Inf. The third module is 'AGC(Pre)' with parameters: AGC On/Off, Target -20-20dBu, Gain 1 to 20dB, Window 1 to 10dB, Hold 30 to 200ms, Low Thresh -60to-30dB, and Attack .20 to 5 sec, Release 30 to 1.0dB/s. The fourth module is 'LIMITER' with parameters: Limiter On/Off, Over Easy Off, 1-10, Threshold -40-20dB, PeakStop On/Off, Auto On/Off, Overshoot 2 to 6dB, and Attack 0.1 to 200ms, Hold 30 to 200ms, Release 360 to 5.0dB/s. Below the 'LIMITER' module is the 'AGC(Post)' module with parameters: AGC On/Off, Target -20-20dBu, Gain 1 to 20dB, Window 1 to 10dB, Hold 30 to 200ms, Low Thresh -60to-30dB, and Attack .20 to 5 sec, Release 30 to 1.0dB/s.

The Comp/Limiter button toggles through the AGC Compressor or Limiter modules used in each channel of the selected program.



Successive presses of the Data wheel will select effect parameters within the currently selected page.

2.7 Navigating the Delay Section

From program mode, press the Delay button. Pressing the Data Wheel will select the effect parameter to be edited. Successive Presses of the Delay button will move you through pre and post crossover delays.

DELAY

DELAY



Delay - On/Off
Length - Delay Time - Course, Fine
Units - Seconds,Feet,Meters



Successive presses of the Data wheel will select effect parameters within the currently selected page.

2.8 Navigating the Utility/Meters Section

From program mode, press the UTILITY button. Pressing the Data Wheel will select the effect parameter to be edited. Pressing and holding the Utility button will enter you into the meter menu.

UTILITY

<PREV PG



NEXT PG>



UTILITY



LCD Contrast - 1-16
AEQ Plot - RTA/GEQ

PUP Prog. - Current/Stored
PUP Mute - Current/Stored

ZC Panel - 1-6
(Store) - Edit Panel

Security Level - Module Select
Security Level- Low, Med, High

260 Device Level-
Low, Med, High

Edit High Password
Edit Medium Password

Program List Size- 1-10
List Index - 1-10

Program Change mode
Normal/Program
Program Number Lock 1-25

Output Jumpers - 1-6
Setting - 14, 22, 30dB

METERS

Noise gate-
AGC-

Limiter 1-3

Limiter 4-6

Zone Controller-
1-3

Zone Controller-
4-6

Output Trims
1-3

Output Trims
4-6



Successive presses of the Data wheel will select effect parameters within the currently selected page.

2.9 Navigating the Wizard Section

From program mode, press the RTA/WIZARD button. Pressing the Data Wheel will select the effect parameter to be edited.

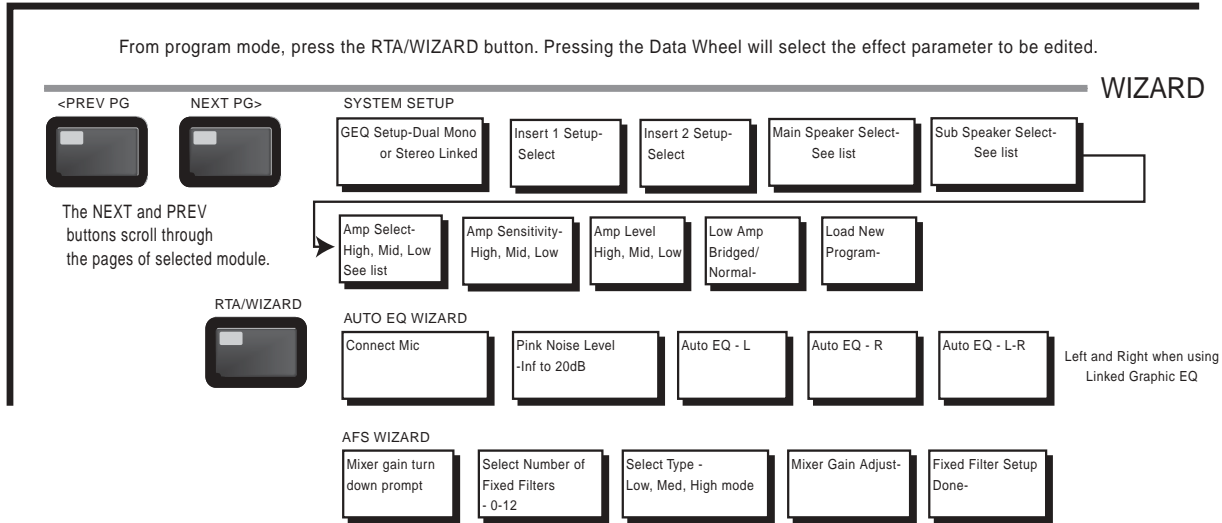

Successive presses of the Data wheel will select effect parameters within the currently selected page.

2.10 Navigating the I/O Section

From program mode, press the I/O button. Pressing the Data Wheel will select the effect parameter to be edited.

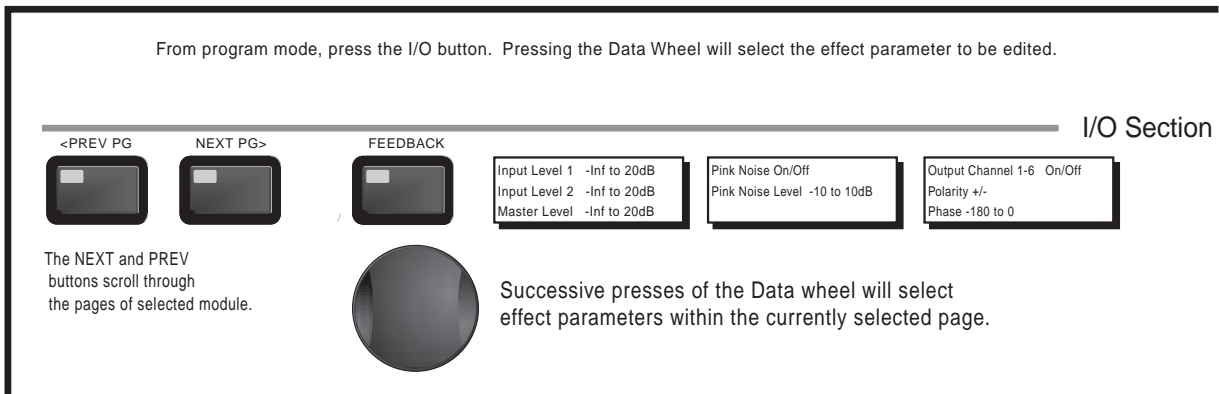

Successive presses of the Data wheel will select effect parameters within the currently selected page.

DriveRack™

Section 3

SOFTWARE

CONFIGURATION FUNCTIONS



dbx[®]
PROFESSIONAL PRODUCTS

The Configuring section of the 260 DriveRack will be your key to successful navigation of the configuration functions of the DriveRack. The following information provides descriptions about program functions and in depth configuration options of the 260 DriveRack.

3.1 Program Definition

The first step in understanding the programming capabilities of the DriveRack is to understand the components of a complete “program.” Within an individual program, there are several levels of editing that make up the complete program. When initially entering a program, you will be at the “program” mode level. This level supplies the user with current program information such as: current signal path, effect usage, and program name. From this point, the 260 DriveRack gives you the option of entering subsequent levels of operation that are dedicated to program editing. These levels include Configuration mode and Effect Edit mode. All of these components combined, make up the conventional “program”, and they are all unique to each individual program. The Utility menu mode is accessed via the utility menu, and is not part of a single program.

3.2 Navigating Factory Programs

From the factory, the 260 DriveRack™ is shipped with 25 factory programs that have been designed to accommodate virtually any sound reinforcement and installation application. The factory programs offer a clear and concise explanatory title to get you up and running in a timely manner. These programs can also be used as templates or starting points for the user to create custom programs.

Selecting Programs:

The quickest way to get up and running with the DriveRack™ is to use any one of the factory programs that are available in the box. To select a factory program, (from program mode), use the **Data Wheel** to scroll through the various factory programs. As each factory program is selected, the display will clearly indicate the title that is directly related to a specific application. Once a program is selected, press the **PROGRAM/CONFIG** button to load the program. The display will appear something like this:

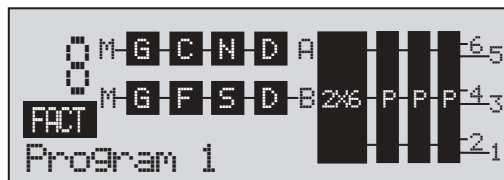

Navigation Modes

Once you have selected a program with a configuration that accommodates your application, the DriveRack offers instant access to edit effect types within the configuration.

To instantly access an effect module, simply press the corresponding button in the button array for the desired module.

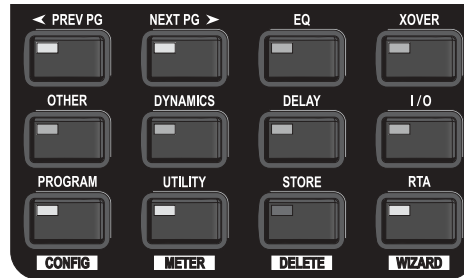

3.3 Editing Factory Programs

Once you have reached the module that you wish to edit, use the **PREV PG** and **NEXT PG** buttons to move through the pages within the module. The **DATA** wheel is used to edit parameter values. The following illustration shows an example of the Dynamics module in edit mode:

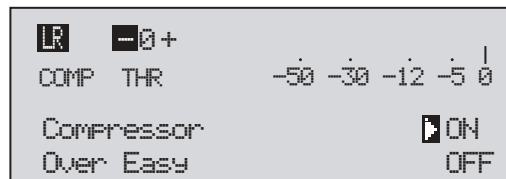

Note that the cursor indicates the currently selected parameter for editing. To select parameters to edit from the current page, press the **DATA** wheel until the cursor is next to the parameter that you wish to edit.

3.4 Saving Factory Programs Changes

Once you are satisfied with the changes that have been made to a factory or user program, the DriveRack allows you to save these changes to the program as a custom USER program by pressing the **STORE** button. The display will appear something like this:

```

NAME:  ROCK VENUE
<DATA> - SELECTS CHARACTER
<PREV/NEXTPG> - LEFT/RIGHT:
PRESS <STORE> TO ADVANCE

```

- Rotating the **DATA** wheel will change the characters in the currently selected position.
- Pressing the **DATA** wheel will toggle between upper and lowercase letters, numbers or symbols.
- Use the **PREV PG** and **NEXT PG** button to move character positions.
- Once the desired title has been written, press the **STORE** button. The display will now appear something like this:

```

STORE: Program 1
Replacing:
U 1 Program 1
PRESS <STORE> TO ADVANCE

```

- Rotate the **DATA** wheel to select the program to be replaced and press the **STORE** button and the existing program will be replaced with the new program. All edits will be saved.

The 260 DriveRack will store up to 25 user programs in addition to the 25 factory programs. Note: Factory programs cannot be over-written. Replacing a factory program will move the program index to a user program.

3.5 Creating a User Configuration

User Configuration is an ideal feature available in the 260 DriveRack. Even with the versatility of the Factory configurations within the DriveRack, there may be an application that requires a unique “custom” program configuration. The DriveRack gives you the ability to create a custom routing configuration by selecting and modifying the modules including: Inputs, pre-crossover EQ, an insert section which includes: Notch Filter, Compressor, Gates, AGC, Subharmonics Synthesizer and AFS (Advanced Feedback Suppression), Crossovers, Post-crossover Parametric EQ, Dynamics, Post Delay, Output Gain and Phase. The following information contain a standard block diagram of the signal path in the 260 DriveRack which can be used as a reference map, as well as step-by-step instructions for creating custom user configurations.

260 Signal Path

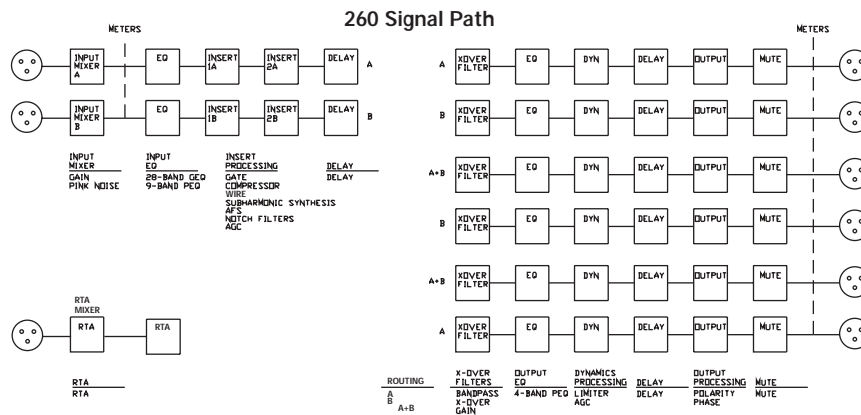

- From Program mode, press and hold the **PROGRAM/CONFIG** button until the bottom corner of display reads: “Configure”
- At this point, you can either press the button of the module that you wish to edit ie: DYNAMICS, or if you wish to change every module within the signal path, you can use the **PREV PG** and **NEXT PG** buttons to move through every module within the signal path. The following information will make a basic touch on every module. The first page in configuration mode will appear as follows:



- You are now in the Pre-Crossover EQ module. The arrow indicates that EQ type is selected. Rotate the **DATA** wheel to select either Parametric (PEQ) or Graphic (GEQ). Pressing and then rotating the **DATA** wheel lets you link or unlink the A and

B modules. Note that the same EQ types must be selected to link. Use the **PREV PG** and **NEXT PG** buttons to move through A and B, and then to the next module screen which will appear something like this:



- You are now in the Pre-Crossover Insert module. The arrow (in correspondence with the Module 1 or 2 indicators, along with the A and B indicators indicate which module block is currently selected. Rotate the **DATA** wheel to select either Wire, AGC, Compressor, AFS, Noise Gate or Subharmonic Synthesizer. Pressing and then rotating the **DATA** wheel lets you link or unlink the A and B modules. Note that the same Effect types must selected to link. Use the **PREV PG** and **NEXT PG** buttons to move through A and B, 1 and 2 and then to the next module screen which will appear something like this:

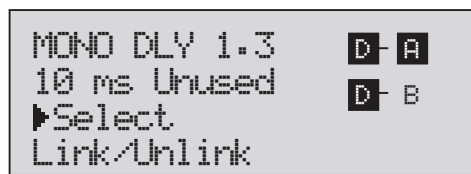

- You are now in the Pre-Crossover Delay module. The arrow (in correspondence with the A and B indicators indicate which module block is currently selected. Rotate the **DATA** wheel to select Delay type and time. Pressing and then rotating the **DATA** wheel lets you link or unlink the A and B modules. Note that the same Effect types must selected to link. Use the **PREV PG** and **NEXT PG** buttons to move through A and B, and then to the next module screen which will appear something like this:

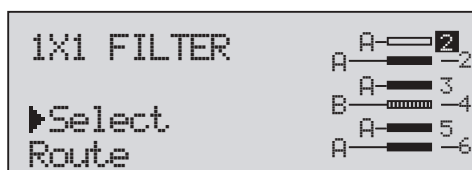

- You are now in the Crossover module. The arrow (in correspondence with the with the A and B indicators indicate which module block is currently selected. Rotate the **DATA** wheel to select Crossover type. Pressing and then rotating the **DATA** wheel lets you select the route path. You can route either Input A, Input B or the summed Input A+B to any mono input crossover. A stereo crossover can only have A and B routed to its two inputs. Use the **PREV PG** and **NEXT PG** buttons to move through A and B, Outputs 1-6 and then to the next module screen which will appear something like this:

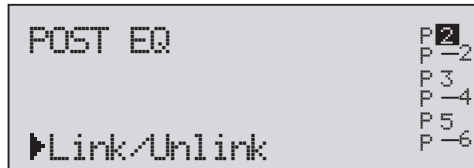

- You are now in the Post-Crossover EQ module. The arrow indicates that EQ type is selected. Rotate the **DATA** wheel to select the Parametric EQ type. Use the **PREV PG** and **NEXT PG** buttons to move through outputs 1-6, and then to the next module screen which will appear something like this:

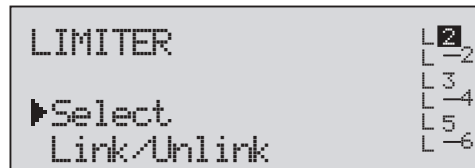

- You are now in the Post-Crossover Dynamics module. The arrow indicates that that either the Limiter or AGC type is selected. Rotate the **DATA** wheel to select the Dynamic type. Use the **PREV PG** and **NEXT PG** buttons to move through outputs 1-6, and then to the next module screen which will appear something like this:

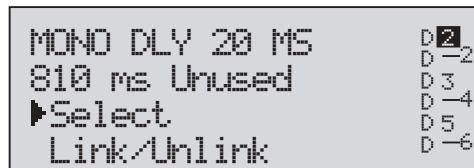

- You are now in the Post-Crossover Delay module. The arrow (in correspondence with the with the output 1-6 indicators indicate which output delay module block is currently selected. Rotate the **DATA** wheel to select Delay type and time. Pressing and then rotating the **DATA** wheel lets you link or unlink the output delay1-6 modules. Use the **PREV PG** and **NEXT PG** buttons to move through Outputs 1-6, and then to the next module screen which will appear something like this:

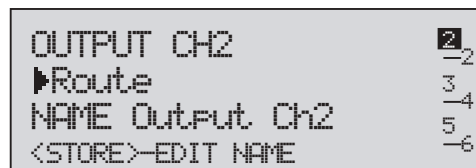

- You are now in the Output Route and naming module. The arrow (in correspondence with the with the output 1-6 indicators indicate which output module block is currently selected. Rotate the **DATA** wheel to select Output route. Pressing the **STORE** button will move you to naming page which appears something like the following display:

```
NAME: Output Ch2
<DATA> - SELECT CHARACTER
<PREV/NEXTPG> - LEFT/RIGHT
<STORE>-EDIT/<UTIL>-EXIT
```

- Once all of the naming assignments have been made, press the UTILITY button to return to Configuration mode. If all Configuration modifications you can press the PROGRAM button to return to program mode where you will proceed to Store your new USER configuration.

3.6 Saving Configuration Changes

Once changes have been made to the current Configuration, changes can be saved by pressing the **STORE** button and the display will appear like this:

```
NAME: ROCK VENUE
<DATA> - SELECTS CHARACTER
<PREV/NEXTPG> - LEFT/RIGHT:
PRESS <STORE> TO ADVANCE
```

At this point, enter the new name for your configuration. If you wish to abort at this point, press the **PROGRAM/CONFIG** button.

DriveRack™

Section 4

PARAMETERS

DETAILED
PARAMETERS



dbx[®]
PROFESSIONAL PRODUCTS

The 260DriveRack offers complete editing flexibility, by offering in-depth control over every parameter within each effect module. The following section will provide you with descriptions and explanations of all parameters within the 260 DriveRack.

4.1 Pre-Crossover EQ

The 260 DriveRack's Pre-Crossover EQ section may be configured as a single or linkable 28 band graphic EQ or 9-Band PEQ.

GEQ

EQ On/Off

Turns the EQ on and off.

Flatten/Restore

This parameter either flattens the GEQ or restores the GEQ to the last setting before flattening. The DriveRack unit allows you to leave the EQ edit window and return without losing the edited EQ settings.

Frequency (F) 31.5Hz to 16.0kHz

This parameter allows you to select any one of the 28 available frequencies.

Gain (G) -12 to +12 dB

This parameter allows you to adjust the level of any one of the 28 bands of the GEQ in .5 dB increments.

PEQ

EQ On/Off

Turns the PEQ on and off.

Flat Set/Undo

This parameter either flattens (set) or restores (undo) all bands to their original settings.

Band 1 Frequency 20 to 20kHz (Low Shelf)

Selects the frequency of the low pass shelf parametric EQ.

Slope 1 3-12dB/Octave

Sets the slope of the low shelf parametric EQ.

Level 1 -12 to 12 dB

Sets the overall gain of the shelf EQ.

Band (2-8) Frequency 20 to 20k

Selects the frequency of the selected band of the parametric EQ.

Q (2-8) 0.20 to 16.0

Adjusts the Q of the selected band of the parametric EQ.

Level (2-8) -12 to 12 dB

Sets the overall level of the selected parametric EQ frequency.

Band 9 Frequency 20 to 20k (High Shelf)

Selects the frequency of the high shelf parametric EQ.

Slope 9 3-12dB/Octave

Sets the slope of the high shelf parametric EQ.

Level 9 -12 to 12 dB

Sets the overall gain of the high shelf parametric

4.2 Feedback Eliminator

The 260 DriveRack offers the exclusive patent pending AFS (Advanced Feedback Suppression) feedback elimination module. Feedback is caused when a microphonic signal such as a guitar pickup or microphone is reproduced by an amplification and is repeatedly picked up in phase. The AFS uses Precision Frequency Detection and state-of-the-art processing to determine the exact portions of a given frequency of your feedback that need to be removed (instead of taking out large sections of your sound). The AFS module of the 260 DriveRack allows the user to optimize the elimination of feedback. In the past, graphic equalizers were used to eliminate feedback from a system. This was an acceptable method for eliminating feedback, but when this method was precision tested, the result clearly showed that a single 1/3 octave EQ slider was removing approximately half of the signal power. With the AFS, the module removes the feedback automatically and the proprietary, precision AFS filters remove only a fraction of the frequency spectrum. The following diagram shows AFS as opposed to competing, competitive feedback eliminators and conventional graphic EQs:

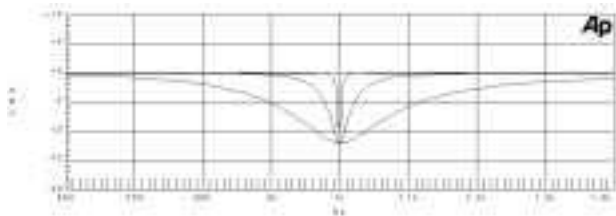
**AFS On/Off**

Turns the AFS module on and off. If AFS is Off, the filters are bypassed, and the algorithm is halted (the filters are not updated). If AFS is On, the filters are active, and they are updated according to the current selected mode (Fixed or Live).

Clear Live/All

This parameter clears the filters. If Clear Live is selected, then (if invoked) the live filters are reset. If Clear All is selected, then (if invoked) all of the filters are reset. When either Clear Live or Clear All is selected, the third parameter row displays “Start w/ Data Wheel.” If Clear (none) is selected, then nothing is displayed on this row. When the user moves to this third row and turns the Data Wheel (when Clear Live or Clear All is selected) then the filter reset is invoked.

Mode - Live or Fixed

When the mode is Fixed, the algorithm updates only the fixed filters. When the mode is Live, the algorithm updates only the live filters. In FIXED mode, the filters are automatically assigned to a frequency creating feedback, are stored remain with the program and at that frequency until cleared by the user. Fixed mode is used before the performance without any input signal. In LIVE mode, the live filters automatically detect and remove feedback during the performance. When all of the live filters have been used, they begin to round robin. Essentially this means that the first filter set

is replaced where a new feedback is detected and notched out. This mode is useful because feedback frequencies may change as the microphone is moved, and/or as the characteristics of the venue change. Note- Only the fixed filter settings will be stored with the new program.

Type - Speech, Low Music, Medium Music and High Music

If Fixed or Live mode is chosen, the text will read "Type." The options will be Speech, Music Low, Music Medium and Music High. These types pertain to the Q, sensitivity, and algorithm type. Values are; Speech (Bandwidth = 1/5 octave and Q=7.25) Music Low (Bandwidth = 1/10 octave and Q=14.5) Music Medium (Bandwidth = 1/20 octave and Q=29) Music High (Bandwidth = 1/80 octave and Q=116). Note: To guarantee that feedback is suppressed at lower frequencies, the AFS may place wider notch filters at these lower frequencies (below 700 Hz).

Number Fixed - 0-12

This will range from values 0-12. The total number of filters will stay at 12, and the number of live filters will be = Total Num Filters - Num Fixed. If this is changed before the filters are reset, then the filters will be reset one by one as the number changes. For example, if the number of Fixed filters goes down, then the last fixed filter set will be reset. Likewise, if the number of Fixed filters goes up (and thus the number of live filters goes down), then the last live filter set will be reset. The Fixed/Live filter usage will be indicated at the bottom of each page of the feedback elimination effect. 'F' indicates an available fixed filter, and 'L' indicates an available live filter. A blocked out F or L indicates a filter that is set, or in use.

Live Filter Lift (On/Off)

This parameter turns the Live Filter Lift on and off.

Lift After - 5 sec to 60 min

This parameter allows the user to setup the box so that the Live filters will automatically be removed after a set time (as indicated by the "Lift After" parameter). It ranges from 5 seconds to 60 minutes. This feature is useful if the microphone being used is moved or the characteristics of the venue change over time. As example; a filter placed minutes ago will not be presently preventing feedback. This feature removes unnecessary filters from the spectrum to increase sonic quality. If the feedback is still there (after the filter is removed), it will catch it and notch it out the same.

Total Number of Filters 1-12

This parameter selects the number of filters being used

4.3 Subharmonic Synthesizer

The Subharmonic Synthesizer module has been specifically optimized to enhance Bass audio material for use in a variety of professional applications, including nightclub and dance DJ mixing, theatre and film sound, music recording, live music performance and broadcasting.

The Subharmonic Synthesizer module's two separate bands of subharmonic synthesis provide the best combination of smoothness and control, and the independent low frequency boost circuit is designed to get the most out of high-performance low frequency speaker systems.

Sub-Harmonic Synth - On/Off

Turns the Subharmonic Synth module on and off.

Sub-Harmonics Synth - 0 to 100%

This parameter sets the overall level of the Subharmonic Synthesizer.

24-36Hz and 36-56Hz (Subharmonic Synthesis) Level - 0 to 100%

These controls individually let you customize the amount of the respective synthesized frequencies to be added in, tuning the ultimate bass response of your system to taste. For example, if the sound is too woofy or growly, try turning down the 36Hz-56Hz level. If your woofers are bottoming out (making a ticking, popping sound), try turning down the 24Hz-36Hz level. You may find that a setting produces fine results in one room, but produces too much boominess in another. If this occurs, adjust the controls as needed, (e.g., increase one or the other of the band levels). Experimentation will pay off with smooth, full, deeply extended bass. Remember, you are not selecting a frequency. You are controlling the overall level of each band.

4.4 Gate**Gate On/Off**

Local (per band control) or global on and off.

Threshold -50 to 20 dBu

The threshold is the volume level at which the gate opens. Anything above the threshold passes, while signal that is lower than the threshold is attenuated. Beware, setting the threshold to high can cut off the tail end of signals as they fade out (the sustain of a guitar note, a held piano chord, a reverb tail, etc.).

Ratio 1:1.0 to 1:15

This is where you decide how much downward expansion you want. This ratio works opposite from that of the compressor or limiter. If a ratio of 1:4 is selected, a signal that is 1dB below the threshold will be reduced in gain so that it becomes 4dB below the threshold.

Attack 0.1 to 200 m Sec

As the signal reaches the threshold area, the Attack control sets the speed at which the gate opens. Use very fast attack times to catch the fronts of transient signals.

Hold 0 to 500 m Sec

The Hold control sets the amount of time the gate is held open after the signal passes below the threshold point.

Release 360 to 5 dB

Release sets the speed at which the gate “closes” or attenuates when the end of the Hold time is reached.

Max ATT 0 to Inf. dB

This sets the maximum amount of attenuation for the gate.

4.5 Automatic Gain Control (AGC)

The AGC is used to keep the average level of a signal at a constant level. This is done by selecting a desired Target output level and Window. The AGC keeps the signal within the Window about the selected Target by slowly adjusting the gain. The maximum gain that can be applied to the signal is selected by the Gain parameter. When the input signal falls below the Low Threshold the AGC releases the gain and returns to unity. This prevents the AGC from adding gain when there is no signal present and raising the system noise floor. High level signals are reduced by a fast limiter to prevent distortion by clipping. The AGC Threshold meters show what region of the AGC the input signal is in. The T (yellow) indicates the signal is within the Window. A + (red) indicates the signal is going into the Limiter. A - (green) indicates the AGC is adding maximum Gain and is at or below the Window. When the Threshold meter is off the signal is below the Low Threshold.

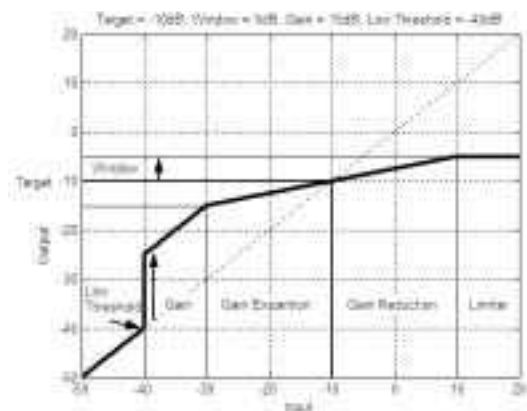

AGC: On/Off

Turns the AGC module On and Off.

Target: (Targ) -20 to 20 dB

The Target parameter defines where you would like the average level of the AGC output to be. If the average level of the signal rises above the Target the gain will be reduced. For signals with an average level below the Target the gain will be increased.

Gain: 1 to 20dB

This adjusts the maximum amount of gain that can be added by the AGC.

Window: 1 to 10dB

This adjusts the amount of variation in the output

Low Threshold: -60 to -30dB

The Low Threshold sets a lower limit to the AGC. This prevents the AGC from adding gain to low level signals or noise.

Attack: 0.20 to 5 Seconds

This adjusts how fast the AGC will increase gain.

Release: 30.0 to 1 dB/Second

This adjusts how fast the AGC will reduce gain.

4.6 Notch Filters

The notch filter is the perfect tool for dropping out undesirable frequencies that may appear in the input signal. Up to six Notch filters are available for all six outputs.

Notch On/Off

Turns the notch filters on and off.

Frequency (1 to 6) 20 to 20K

Selects the desired notch filter frequency of the selected notch filter.

Gain -36 to 6 dB

Sets the level of the selected notch filter. Set to +6dB to help find unwanted feedback, then set to -3dB to -36dB to remove.

Q 16 to 128

Selects the Q of the selected notch filter.

4.7 Crossover

The Crossover is used to divide the input signal into several frequency bands. This allows the user to drive the speaker in its optimum frequency range and send each output separately for more efficient use of amplifier power. The 260 DriveRack Crossover can be configured as a 2x3, 4, 5, or 6. Appendix A.5 illustrates each of the available crossovers. The High-Pass or Low-Pass filter being edited is indicated by the highlighted edge in the graphics area.

Frequency

Adjusts the frequency of the Low Pass filter from 20 to 20KHz.

Type

Selects the filter type. Selections are: BS 6, 12, 18, 24 Bessel type filter, BW 6,12,18,24 for Butterworth type filter with slope of 6, 12, 18 or 24 dB/Octave and LR12, 24 for Linkwitz-Riley type with slope of 12 or 24 dB/Octave.

Gain

Sets the level of the selected crossover band. Range is from Infinity to +20dB.

4.8 Post-CROSSOVER PEQ

In addition to the pre-crossover EQ options within the signal path, the 260 DriveRack also offers a 2 or 3-band parametric EQ after the crossover section. The parameters for the post-crossover EQ are as follows and are user adjustable.

PEQ On/Off

Turns the PEQ band on and off.

The following figure shows the constant Q parametric filter.

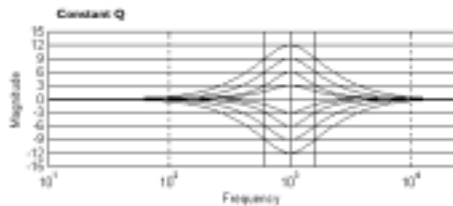

Flatten/Restore

This parameter either flattens the PEQ or restores the PEQ to its original shape.

Type

This parameter selects the PEQ type. Types include: 1. Bell-All parametrics are bell-shaped 2. HShelf - One shelf is High, while all others are bell 3. LShelf - One shelf is Low, while all others are bell and 4. LHSshelf - One shelf is High and one is Low, and the others are bell.

Band (1-4) Frequency 20Hz to 20kHz

Selects the frequency of the selected band of the parametric EQ.

Level (1-4) -12dB to 12dB

Sets the peak level of the selected parametric EQ.

Q (1-4) 0.20 to 16 dB

Sets the Q or Bandwidth of the selected Parametric EQ.

4.9 Compressor/Limiter

The 260 DriveRack also offers Compression and Limiter modules. The Compressor is a full bandwidth Stereo Compressor inserted prior to the Crossover. The Compressor is the perfect tool for tightening uneven signal sources such as vocals and guitars. The Limiters are located on each output channel and have been strategically placed for speaker and amplifier protection. Note that Compressor/Limiter threshold metering can be observed in the Meter section by pressing and holding the Utility button. The parameters for the Compressor/Limiter are as follows and are user adjustable.

COMPRESSOR

Compressor On/Off

Turns the Compressor module on and off.

OverEasy (O) Off to 10

There are ten levels of OverEasy® that can be used for the limiters. The point when the compressor starts to compress is the "knee." When the compressor starts to reduce the level of a signal abruptly as it passes over the threshold, this is called "hard knee" compression. OverEasy® (soft knee as it is sometimes called) is when the volume of the sound is compressed gradually. OverEasy® compression starts to compress before the level of the signal reaches the threshold and reaches full compression after the level has gone above the threshold. OverEasy® compression, by its very nature, sounds much smoother and more natural and will be used for most applications. When it is gentle (natural sounding or light) compression that you are looking for, the compressor offers VariKnee™. VariKnee™ gives you ten levels of OverEasy® compression to choose from (1 being almost hard knee and 10 being the most OverEasy®). This lets you choose the exact knee that is needed for the dynamic effect you are looking for.

Threshold (T) -40 to +20dBu

Threshold is the signal level at which the unit starts to compress the signal. If the level is set to -10 dBu, than any signal larger than -10 dBu is compressed while any signal that has a level that is lower than -10dBu is left at the same signal level. Light compression is where only the loudest parts of the signal go over the threshold. Very heavy compression can be achieved by setting the threshold low enough that almost the entire signal content is over the threshold. For most signals the most natural compression is achieved when most of the signal content remains just below the threshold and only the peaks cross the threshold.

Ratio (R) 1.0 to Inf:1

Ratio is the amount the unit reduces the signal level of the sound that is above the threshold. A 2:1 ratio means that if the incoming signal is 2dB over the threshold the unit will compress the signal, and outputs a signal that only goes 1dB over the threshold. For light compression choose a lower ratio, while a heavy compression requires a higher ratio. A setting of Inf:1 makes the compressor act as a limiter.

Gain (G) -20 to +20 dB

This parameter is used to compensate for the gain lost during compression. By using heavy compression on a signal and then boosting the signal with the output gain, the user can create a signal that sounds much louder than it actually is.

Auto On/Off

When Auto Mode is on, the 260 automatically sets the Attack, Hold, and Release times for the signal. The auto mode constantly adjusts these parameters in real time for optimum performance from the unit. You will find that for most applications, not only is using the auto mode faster and easier but by letting the unit constantly tweak these parameters for you will result in a better end result (try and hit a snare exactly the same for three minutes).

Attack 0.1 m Sec to 200 m Sec

Attack is how fast the compressor starts to compress the signal after it passes the threshold. Fast attack is useful when dealing with lots of fast transients. The attack control is not active when in auto mode.

Hold 0 to 500 m Sec

Hold is the time the 260 remains in compression after the signal has dropped below the threshold. A longer hold time is useful in smoothing out the sound when compressing several fast peaks that are fairly close together in time. In general some hold time helps to make the compression sound more natural but too much can over compress your signal making for an unwanted drop in level. The hold control is not active while in auto mode.

Release 360 dB / Sec to 5 dB / Sec

Release is how fast the 260 comes out of compression. The release is in dB per second. For example, if release is set to 5 dB /sec, and the signal is at 10dB of gain reduction, the release time is 2 seconds. Too fast a release time can result in an audible volume jump, while too slow a release time can result in the compression of signal that is not above the threshold. This can cause volume drops in your signal that may not be desired. The release control is not active while in auto mode.

LIMITER**Limiter On/Off**

Turns the Limiter module on and off.

OverEasy (O) Off to 10

There are ten levels of OverEasy® that can be used for the limiters. The point when the compressor starts to compress is the "knee." When the compressor starts to reduce the level of a signal abruptly as it passes over the threshold this is called "hard knee" compression. OverEasy® (soft knee as it is sometimes called) is when the volume of the sound is compressed gradually. OverEasy® compression starts to compress before the level of the signal reaches the threshold and reaches full compression after the level has gone above the threshold. This OverEasy® compression, by its very nature sounds much smoother and more natural and will be used for most applications. When it is gentle (natural sounding or light) compression that you are looking for, the compressor offers VariKnee™. VariKnee™ gives you ten levels of OverEasy® compression to choose from (1 being almost hard knee and 10 being the most OverEasy®). This lets you choose the exact knee that is needed for the dynamic effect you are looking for.

Threshold (T) -40 to +20dBu

Threshold is the signal level at which the unit starts to compress the signal. If the level is set to -10 dBu, any signal larger than -10 dBu is compressed while any signal that has a level that is lower than -10dBu is left at the same signal level. Light compression is where only the loudest parts of the signal go over the threshold. Very heavy compression can be achieved by setting the threshold low enough that almost the entire signal content is over the threshold. For most signals, the most natural compression is achieved when most of the signal content remains just below the threshold and only the peaks cross the threshold.

Auto On/Off/

When auto is turned on the 260 will continuously set the attack / hold / release controls itself.

Attack .01 to 200 m Sec (per band or global)

This is the speed at which the 260 limiter starts to compress the signal once it has crossed the threshold. Set the attack time longer for lower frequency bands, and shorter for higher frequency bands.

Hold 0 to 500 m Sec (per band or global)

Hold is the time the limiter stays in gain reduction after the signal level has dropped below threshold. Hold is useful when you want the limiter to function for a period of time after it has been triggered. **Be careful not to set the hold time too long as it will not release in time.**

Release 360 to 5 dB / Sec (per band or global)

Just like the release time on the compressor, the limiter's release time controls how fast the limiter releases from gain reduction after the signal drops below the threshold. Set the release times longer for lower frequency bands and shorter for higher frequency bands.

Peakstop+™ On/Off and 1-6

This parameter turns the peakstop limiting on and off.

PeakStop+ involves a two-stage process of dynamic limiting. The first stage of PeakStop+ is the Instantaneous Transient Clamp™ which clamps the signal with a soft logarithmic clamp function. This logarithmic function ensures that the signal will not exceed the level set by the PeakStop+™ OVERSHOOT control by more than the overshoot amount, and that it will not introduce harsh artifacts. The second stage is a unique program limiter featuring Intelligent Predictive Limiting™. Its function is to monitor the input signal and intelligently predict the amount of gain

reduction needed to keep the output signal below the ceiling set by the Instantaneous Transient Clamp™. Note that since the PeakStop+™ limiter is a fail-safe limiter, it must come after the **OUTPUT GAIN** control.

Overshoot 1-6

This parameter sets the amount of overshoot for the Instantaneous Transient Clamp™.

4.10 Alignment Delay

The 260 DriveRack offers alignment delay to use for compensating signal delay that occurs due to internal speaker components such as horns, speakers and subwoofers within speaker cabinets. The alignment delay is also ideal to compensate for the difference in high and low frequency speed. The parameters for the alignment delay are as follows and are user adjustable:

Delay On/Off

Turns the Speaker Alignment delay on and off.

Length

Sets the amount of Speaker Alignment delay time. Delay times include: Seconds- 0.00-2.7 seconds, Feet- 0.00-11.3 and Meters - 0.00-3.43. Fine adjustments are made in 20uS increments. Coarse adjustments are made in 190 msec increments.

Units - Seconds, Feet or Meters

Selects the unit of measurement for the delay.

4.11 Input Routing (IN)

The signal routing begins at the INPUT ROUTING block of the 260. These parameters are user adjustable on all programs.

Input 1 Level -Inf to 20dB

Adjusts the input level of input 1.

Input 2 Level -Inf to 20dB

Adjusts the input level of input 2.

Level Inf to 20dB

This parameter is used to adjust the level for the selected channel.

Master level Inf to 20dB

This parameter is used to control the overall output level of the mixed input signals.

Pink Noise On/Off

Turns the pink noise generator on and off.

Noise Level -10 to 10 (Mixer and Router)

Adjusts the overall level of the pink noise generator.

4.12 Output

The output section 480, 481 and 482 DriveRack™ units provide the user with the ability to control output levels of the unit and adjust phase compensation of loudspeakers within the signal path. The output level control is located in the signal path before the compressor/limiters; this means that the compressor/limiter directly affects the output level. The parameters for the Phase Compensation effect are as follows and are user adjustable. Please refer to section A.9 of the Appendix for a complete output signal routing diagram.

Shift On/Off

This parameter is used to turn the selected output phase parameters on or off. When level is off, phase is 0° and polarity is positive.

Polarity On/Off

This parameter is used to reverse the polarity of the output signal.

Phase 0 to -175°

This parameter sets the amount of phase within the selected output path. The phase is referenced to the upper frequency of the selected output crossover band.

DriveRack™

Section 5

Utilities/Meters

UTILITIES/ METERS SECTION



dbx[®]
PROFESSIONAL PRODUCTS

The Utility section of the 260 DriveRack gives you the ability to perform several key operational functions to the DriveRack including: Security settings, Power-up features, Program list organization, Auto EQ plotting, adjustment of Output Jumper settings and Display contrast settings. Additionally, pressing and holding the utility button will allow you to enter the metering section of the 260. This section lets you monitor aspects of the unit including: Compression, Limiting, Zone Controller levels and Output trim. Use this section of the manual to make yourself familiar with all aspects of the Utility menu of the DriveRack system.

5.1.1 -Page 1 - LCD Contrast / Auto EQ Plot

Page 1 of the Utility menu offers LCD contrast control and Auto EQ Plot selection. Since venues and applications vary, the 260 DriveRack provide you with the option of changing the contrast of the custom display. To make any adjustments to the display contrast, press the **UTILITY** button and the page will appear as follows:

```
Utility
LCD Contrast    ▶10
Auto EQ Plot    RTA
```

- Select the Contrast adjustment by pressing the **DATA** wheel until the contrast percentage is selected. Once the contrast has been selected, proceed to rotate the **DATA** wheel until the desired contrast has been established. Contrast adjust ranges from 01 to 16.
- Select the RTA or GEQ for the Auto EQ plot press the **DATA** wheel until the Auto EQ Plot is selected. Once the desired option has been selected, proceed to rotate the **DATA** wheel select either RTA or GEQ. To exit, press the **PROGRAM/CONFIG** button.

5.1.2 -Page 2 - PUP Program/Mute

The Utility menu of the 260 DriveRack also offers the option of setting the PUP (Power Up) Program option of either Current or Stored and PUP Mutes, which allows to you power up with all outputs either muted or at the last setting prior to powering down. The following explains the difference between Load On and Load OFF settings. To access and edit the Load Stored option of the unit, use the following procedure.

- From Program mode, press the **UTILITY** button and use the **PREV PG** and **NEXT PG** button to move to the page that appears as follows:

```
Power Up Modes
PUP Program    ▶ Stored
PUP Mute       Current
```

Stored: After cycling the power (or power failure), the unit will automatically load a program from the program table. No unstored edits will be saved.

Current: After cycling the power (or power failure), the unit will automatically reload a configuration exactly as it was prior to powering down. This includes any adjustments made to any effect modules including: delays, EQs... etc.

You also have the option of changing the set up so that when the DriveRack™ units are powered up, the output mutes will either power up all muted, or as they were set prior to the unit shutting down. To change the PUP Mute setup, use the following procedure.

- From Program mode, press the **UTILITY** button and use the **PREV PG** and **NEXT PG** button to move to the page that appears as follows:

```

Power Up Modes
PUP Program   ► Stored
PUP Mute      Current
    
```

- Select the PUP Mute adjustment by pressing the **DATA** wheel until the PUP mute is selected. Once the PUP Mute has been selected, proceed to rotate the **DATA** wheel until the desired mute setting (All, Saved) is All= All outputs muted on powerup, Current= Outputs mutes on previous power down. To exit, press the **PROGRAM/CONFIG** button.

5.1.3 -Page 3 - ZC Setup

A unique feature of the 260 DriveRack is its ability to interface with dbx proprietary Zone Controller wall-panel switches. This feature gives you the ability to control various parameters of the 260 such as Boost and Cut Program Changes and Switch closure changes.

- From Program mode, press the **UTILITY** button and use the **PREV PG** and **NEXT PG** button to move to the page that appears as follows:

```

ZC Setup
►Panel 1      None

(STORE) - EDIT PANEL
    
```

- Rotate the **DATA** wheel to select panels 1-6. Once the panel to edit has been selected, press the **STORE** button to edit and the display give you the option of selecting either ZC-1 (volume boost and cut), ZC-2 (volume boost, cut and mute), ZC-4 (four assignable program change presets) and ZC-4 (Switch closure) by rotating the **DATA** wheel. If ZC-1 or 2 are selected, the display will appear something like this:

```

Panel 1      ▶ZC-2
Boost 0dB   Out  0dB
Output 10   30   50
         20   40   60

```

- Pressing the **DATA** wheel will give you the option of selecting the range of the boost and the cut of the potentiometer on the ZC-2 or ZC-2. Once the boost and cut range has been selected, pressing (select) and rotating the **DATA** wheel will let you select any one of the six outputs to be affected by the boost and cut control.
- Selecting ZC-3 gives the ability to assign switches A-D to call up any preset in the 260. Once ZC-3 has been selected, the display will appear something like this:

```

Panel 1      ▶ZC-3
Select A
No Change

```

- Pressing and then rotating the **DATA** wheel will allow you to first select A-D, and then assign any program number to the aforementioned button. No change means that no program will be loaded for that selection.
- Selecting ZC-4 gives the ability to assign any latching switch combination to the 260. Once ZC-4 has been selected, the display will appear something like this:

```

Panel 1      ▶ZC-4
Switch 1-2-3-4
No Change

```

- Pressing and then rotating the **DATA** wheel will allow you to first select any latch switch combination, and then assign it to any program number., and then assign any program number to the aforementioned button.

For more information regarding Zone Controllers, please see section 6.2.

5.1.4 -Page 4 -6 - Security

To protect all detailed parameter editing and configuration modification settings of your DriveRack unit, the Utility menu of the DriveRack system includes a complete security system set-up. This security system allows you to set security access to unit features including: Program List, Store, Mutes, Inputs, Pre EQ, Inserts, Pre Delay, Crossover Post, EQ, Dynamics, Post Delay, Outputs, RTA and Program Lock, with security levels that vary from low to high. By providing

different levels of access, this ensures limited access to different users. This security system also allows you to create unique passwords which will limit/prevent any other users from access to the system. The following information is provided to help you set all security parameters.

- Prior to setting security passwords you will access the security menu by pressing the **UTILITY** button and use the **PREV PG** and **NEXT PG** buttons to move to the first page of security/password pages of the Utility section. The display will appear as follows:

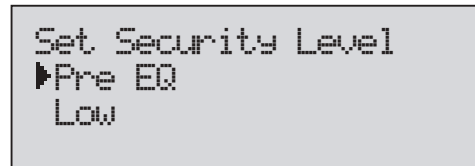

```
Set Security Level
▶Pre EQ
  Low
```

- Note that the arrow indicates the currently selected parameter for editing. To select parameters to edit from the current page, press the **DATA** wheel until the arrow is in the parameter that you wish to edit.
- When the module type is selected, rotating the **DATA** wheel is used to select modules and functions which are available for selecting security levels. Items include: Program changes, Program list, Mutes, Store, Inputs, Pre EQ, Insert 1, Insert 2, Pre Delay, Crossover, Post EQ, Dynamics, Post Delay and Outputs.
- Once the module is selected, press the **DATA** wheel to set the security level for the selected module. The security level (High, Med or Low) type is selected by rotating the **DATA** wheel, which is used to select either the High, Medium or Low level of security for the currently selected module or function.
- Now that security levels have been set for the various modules in the unit, use the **NEXT PG** button to move to the next page of security/password pages of the Utility section which will appear as follows:

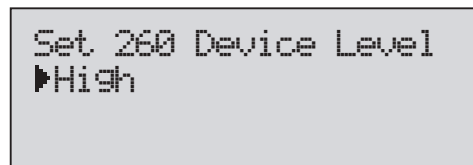

```
Set 260 Device Level
▶High
```

- At this page, you will select the security level of the entire box. Once the device security level has been selected, use the **NEXT PG** button to move to the next page of security/password pages of the Utility section which will appear as follows:

```

Password
▶Edit High Password
  Edit Med Password
  Press Store to Change

```

- Press the DATA wheel to select password to edit. When the level password has been selected, press the store button to select a name. The display will appear as follows:

```

NAME: █ ROCK VENUE
<DATA> - SELECT CHARACTER
<PREV/NEXTPG> - LEFT/RIGHT:
<STORE>-SAVE/<UTIL>-EXIT

```

- Once the password has been entered, press the **STORE** button to save.

Since the security system has three levels (high, med and low), there can be three different levels of users accessing the unit. The high security password user can change/lockout all modules and users, while the medium security password user has access to limited modules and functions and the user with low access will not have access to any modules with security settings with a security clearance high or medium. The following information walks you through the procedure for entering your password once a password has already been entered into the unit.

- From Program mode, press the **UTILITY** button use the **PREV PAGE** and **NEXT PAGE** buttons to move to the security page that appears as follows:

```

Password
▶Enter Password
  Press Store

```

- If you wish to change the security level clearance at this point, press the **STORE** button to enter the password and the screen will appear as follows:

```

NAME: █
<DATA> - SELECT CHARACTER
<PREV/NEXTPG> - LEFT/RIGHT:
<STORE>-SAVE/<UTIL>-EXIT

```

- Once you have entered your security password, press the **STORE** button to store the password and the clearance level will be changed. To abort this procedure at any time, press **PROGRAM/CONFIG** button.
- Press the **PROGRAM/CONFIG** button to return to normal operation.
- After a user with medium or high clearance has completed any edit changes, he or she must remember to set the security level back to low for normal use.

5.1.5-Page 7-8 - Program List/Program Change

The 260 DriveRack units allow you to set the unit to either scroll through programs in a sequential manner, or create custom program lists from within the Utility menu. This list makes it convenient for restricting access to a small list of programs. The program list cannot be changed if the security level is set to lockout access to the program list. The procedure for setting up the program list is as follows.

From Program mode, press the **UTILITY** button and use the **PREV PG** and **NEXT PG** buttons to move to the page that appears something like this:

```

Program List
List Size      ▶10
List Index     1
Program 1
  
```

- Note that the underscore indicates the currently selected parameter for editing. To select parameters to edit from the current page, press the **DATA** wheel until the underscore is under the parameter that you wish to edit.
- Press and then rotate the **DATA** wheel to select List size.
- Once this has been selected, rotate the **DATA** wheel to set the desired list size and then press the **NEXT PAGE** button. Press the **DATA** and for each index in the list, select which program you want the current users to access. The index number is the position of the selected program in the list. To change the number (when it is selected), rotate the **DATA** wheel.

```

Prog Change Mode
▶Program List
Prog Lock      24
  
```

- To set the program number that will correspond with the index number, press the **DATA** wheel. Once this is selected, rotate the **DATA** wheel to select the desired program number.
- Once your program list has been built, press the **PROGRAM/CONFIG** button to exit.

Program lock means that program numbers below the selected number cannot be overwritten.

5.1.6 - Page - 8 - Output Jumper Switches

The Utility menu of the 260 DriveRack also provides you with the option of changing the output levels jumpers from 14dB, 22dB and 30dB from the front panel via the Utility menu. These settings are used by the SETUP Wizard to compute the output gain of the 260. The following information will walk you through this procedure.

- From Program mode, press the **UTILITY** button and use the **PREV PG** and **NEXT PG** button to move to the page that appears as follows:

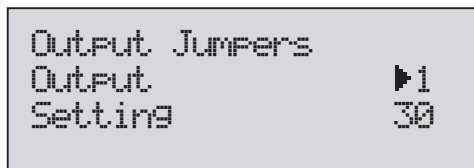

```
Output Jumper
Output      ▶1
Setting     30
```

- Rotate the **DATA** wheel to select the desired output (1-6) to be edited.
- Now press (to select) and rotate the **DATA** wheel to set the desired output jumper level.

5.2.1 - Meters

To meter various aspects of the 260, press and hold the **UTILITY** button until the display enters the Metering section.

- Use the **PREV PG** and **NEXT PG** button to move to the page that appears as follows:



This page meters the gain reduction of any Dynamic block configured in the Insert 1 or Insert 2 block.

- Use the **PREV PG** and **NEXT PG** button to move to the page that appears as follows:

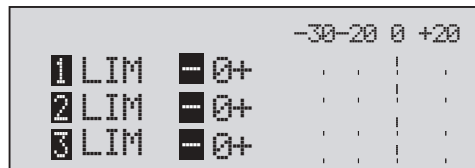

This (as well as the following) page meter the gain reduction on outputs 1-6 of the Limiter module.

- Use the **PREV PG** and **NEXT PG** button to move to the page that appears as follows:

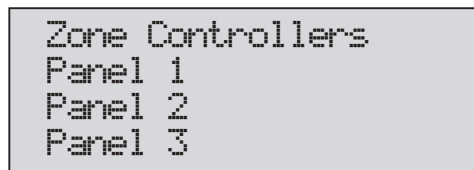

This (as well as the following) page show any activity (such as level changes and program changes) being made by up to 6 activated ZC- Remotes.

- Use the **PREV PG** and **NEXT PG** button to move to the page that appears as follows:

Output Trims			
1	Trim	0.0 Net	0.0 dB
2	Trim	0.0 Net	0.0 dB
3	Trim	0.0 Net	0.0 dB

This (as well as the following) page show the amount of Trim and Net Reduction within the output section.

Remote
Control
DriveWare™
ZC-Remote Zone
Controllers



dbx®
PROFESSIONAL PRODUCTS

To make operation of the DriveWare™ units even more convenient, dbx professional products includes the option of using the DriveRack PC GUI software (included) and the ZC-Remote Controllers (optional). The following section contains some basic information regarding the utilization of the DriveWare software including: install, system requirements, cable specifications and basic operation and basic setup for ZC-Remote Controller applications.

6.1.1 PC GUI Installation

SYSTEM REQUIREMENTS

Min. system- 266mhz PC processor - 16 bit color monitor - 64 meg RAM - Windows™ 95 OS R2 or newer - Windows™ NT 4.0 or newer - Baud rate (fixed) 38.4 kbaud

Note- COMM port setting must be consistent. This means that when the GUI is in use, any other device that uses the RS232 COMM port must be turned off.

INSTALL

- Install the DriveRack™ GUI interface from either the dbx Professional Products website at www.dbxpro.com or from the CD ROM onto your PC or laptop.
- Once the software is downloaded or CD is loaded, double click on the file named: DriveRack™ setup.
- The application will proceed to ask you where you want the program installed.
- Once the software installation has been completed, it is recommended that you restart your computer.
- Make all network device connections prior to running the GUI interface.

The following information offers basic operation information of the DriveRack™ GUI interface

BASIC OPERATION

Once the unit has been connected, boot up the GUI Interface by double-clicking on the application icon. When the program opens, the first view you will see will be the **UNIT** view if the unit is not connected to the PC. This view has icon representations of the unit being used, double-click on the unit to access and edit.

If the unit is connected to the PC, the program will boot up with a block diagram of the unit. To edit modules, double-click on the desired module block.

- To adjust the utility menu, Right-Click-hold on the top bar of the window to pull down the utility menu.

The utility menus will appear as follows:

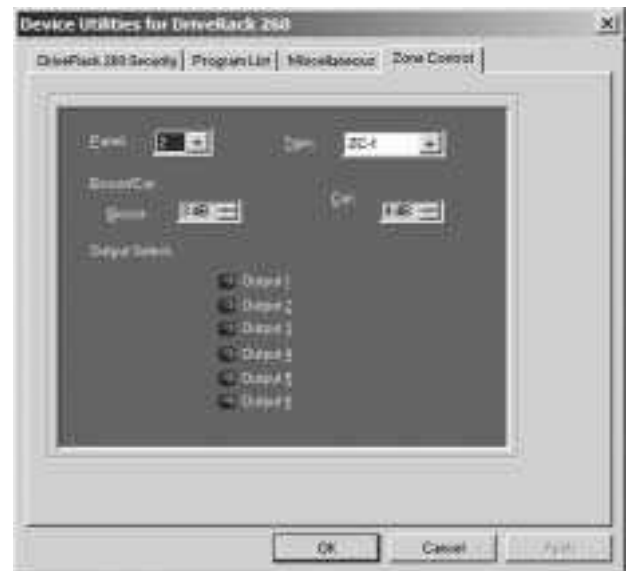
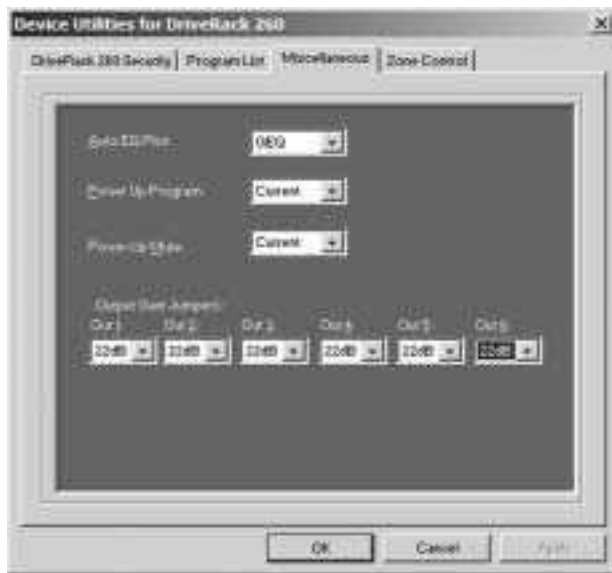
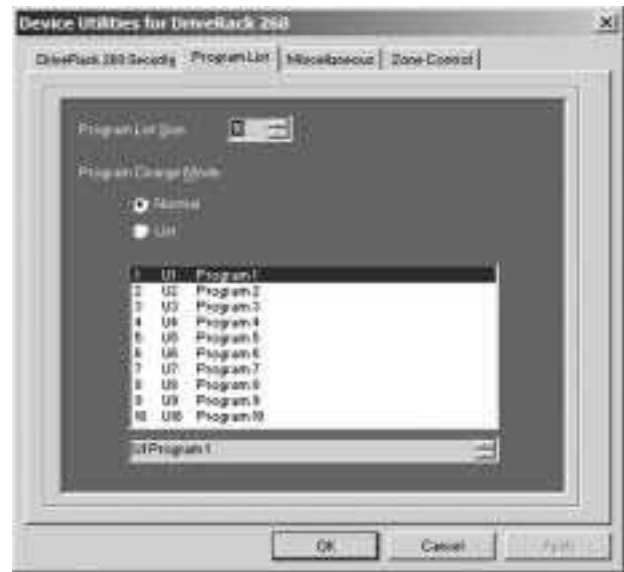

- To customize the mode of operation to best suit your needs, it is recommended that at this point, you set your desired preferences in the preference folder, which can be accessed in the file menu and will appear as follows:



Note: The Baud rate must be set to 38400.

GUI Recommended Cable Specifications:

PC GUI Interface - DB-9 female-to-female nul modem cable. (10 feet)

6.2.1 ZC-Zone Controllers**Zone Controller Installation**

The installation of the Zone Controllers MUST be accomplished with the use of cable which is rated VW-1 or higher. Common NEC designations which meet this rating include: CMP, CMR, CMG, CM and CMX.

The Zone Controllers offer additional utility to the DriveRack™ 260. They allow real-time adjustment of output levels, mutes and program changes from simple wall panel interfaces. On the 260, a maximum number of six Zone Controllers may be used and they may be nested, in other words, one controller may be used for a single zone and then another controller may be used for the entire venue or system. With a maximum distance of up to 5000 ft. on CAT5 cable with RJ-45 connectors, the Zone Controllers offer an easy to program and use remote control surface.

ZC-1

The ZC-1 is a programmable zone controller that allows volume level control from a wall panel.

ZC-2

The ZC-2 is a programmable zone controller that allows volume level and mute control from a wall panel.

ZC-3

The ZC-3 allows wall panel program selection for the 260.

ZC-4

The ZC-4 provides contact closure program selection for room combining applications.

ZC-BOB

The ZC-BOB allows parallel or home run cabling of the Zone Controllers.

Programming

To be programmed, each Zone Controller must have its identification set using the DIP switches on the rear of the panel. The Zone Controllers are programmed from the Utility menus, either from the front panel or from the GUI. To program, each Zone Controller is selected and the outputs and functions are assigned. The ZC-1 allows output selection and Boost and Cut level. The ZC-2 appears exactly the same as a ZC-1 in the Utility menu, but also allows output muting as well as Boost and Cut.

The ZC-3 and ZC-4 allow program selection from either a wall panel, or contact closures. The diagrams on the following page show screen shots from the GUI, a ZC-3 being programmed with the selected programs and the panel that is assigned and a ZC-4 being programmed with up to four contact switches and the program that each of these combinations of switches will load.



Zone Controller Wiring

The DriveRack 260 Zone Controllers, (ZC-1, ZC-2, ZC-3, ZC-4) can be wired serially or in parallel. To wire in series each Zone Controller must have an identification or zone number chosen using the DIP switches on the side of the controller (see diagram A). Each controller must have a unique number chosen although there may be multiple Zone Controllers controlling a single zone, or a single Zone Controller that controls multiple outputs. The Zone Controllers can then be wired together and connected to the DriveRack 260 (see diagram B).

The Zone Controllers may also be wired in parallel with the use of the ZC-BOB. To wire in parallel (home run cabling), each controller must have a unique identification or number chosen using the DIP switches on the rear of the panel (see diagram A). To wire in parallel, each controller must be wired into a port of the ZC-BOB with a connecting wire going to the DriveRack 260 (see diagram C).

Diagram A

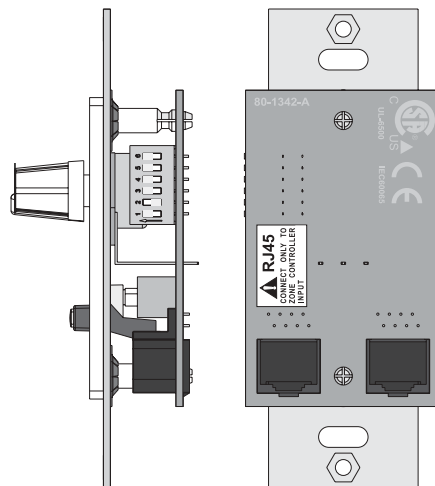

Diagram B

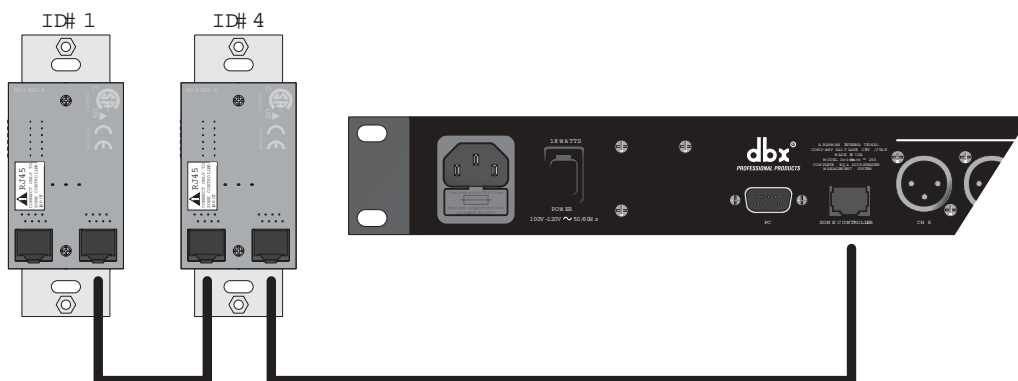
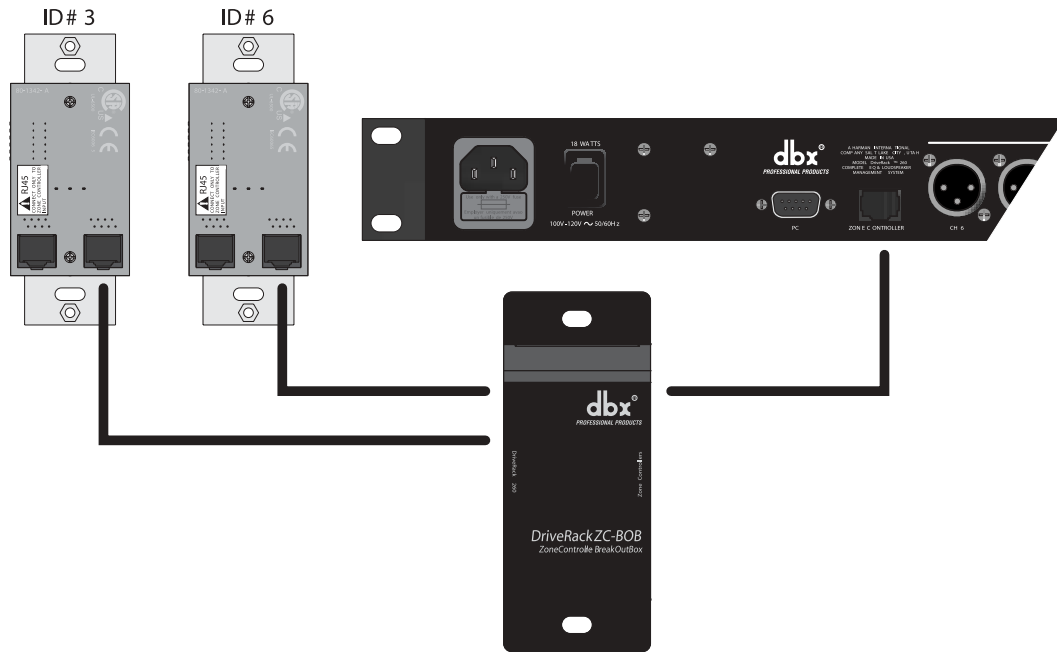

Diagram C



Cable Specification: Cat 5 Cable - 4-Twisted Pairs of 24 AWG wire

RJ-45 (8-Position)		RJ-45 (8-Position)
1	White/Orange	1 -VREF
2	Orange	2 -Zone 1
3	White/Green	3 -Zone 2
4	Green	4 -Zone 3
5	White/Blue	5 -Zone 4
6	Blue	6 -Zone 5
7	White/Brown	7 -Zone 6
8	Brown	8 -GND



6.2.2

Note - The following cable lengths were achieved using Cat5 Enhanced cable exhibiting a maximum D.C. resistance of 29 Ohms per 1,000 feet.

When connecting Zone Controllers in series, the following cable length restrictions apply:

As shown in Diagram A, any (3) Zone Controllers may be wired in series as long as the total cable length does not exceed 600 feet.

Any (6) Zone Controllers may be wired in series as long as the total cable length does not exceed 300 feet. Refer to Diagram B.

Cable runs of up to 1,000 feet may be achieved using "Home Run" wiring. An example of this is shown in Diagram C. A dbx Zone Controller Break Out Box (dbx ZC-BOB) is used to parallel several cable runs. It should be noted that a 1,000 foot cable with a single Zone Controller may be connected directly to the DriveRack 260.

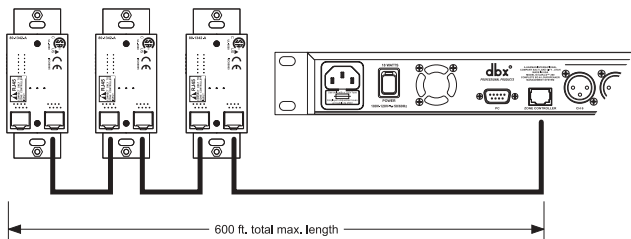

Diagram A

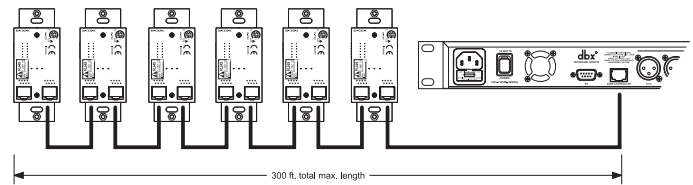

Diagram B

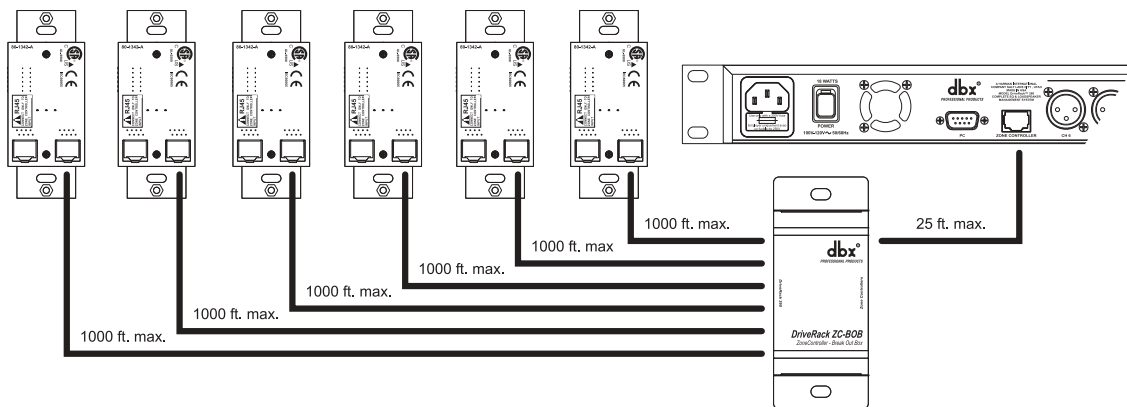

Diagram C

DriveRack™

Section 7

APPLICATION GUIDE



dbx®
PROFESSIONAL PRODUCTS

This Application guide section is provided to offer suggested installation applications of the DriveRack™ units that will allow you to optimize peak performance of the units. Note that the six included applications represent the extensive flexibility of the DriveRack™ units. These applications can be used verbatim, or as sample reference guide templates for designing countless audio applications.

7.1 Mono Four-Way w/ Two Aux Zones

Hardware

1. Connect the outputs from the mixer to the inputs of the DriveRack™.
2. Connect the outputs of the DriveRack™ and run to the selected speaker amplifier.
3. Making sure that all outputs are muted, apply power to the mixer and amplifiers.
4. Make connections between the Zone Controllers (see Section 6.2) and the 260.

Software

1. Select a program (Factory: 2x4 w/ 2 Zones) as a template.
2. Load the program by pressing the PROG/CONFIG button.
3. Adjust the individual parameters for the system by pressing the Processing Module buttons.
4. Using the Utility Menu, select the ID for each ZC-1 and ZC-2 Zone Controller and program its output level boost and cut parameters.

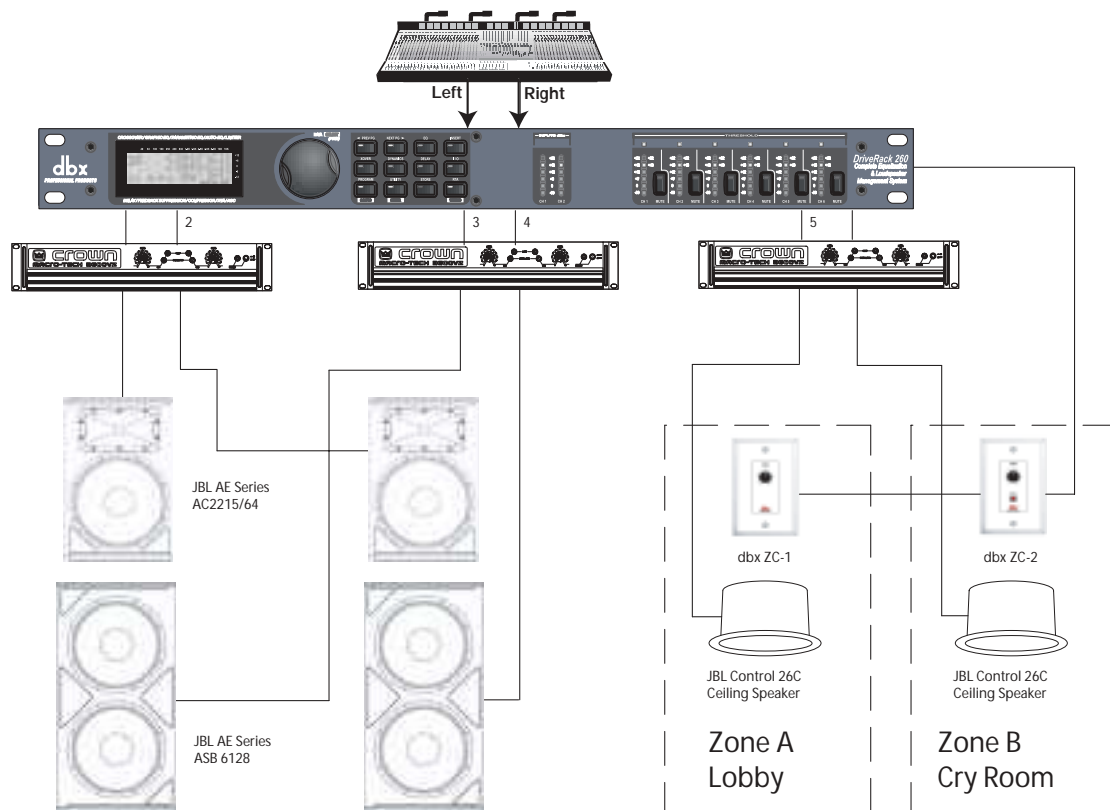

7.2- Stereo Tri-amp

Hardware

1. Connect the outputs from the mixer to the inputs of the DriveRack™.
2. Connect the outputs of the DriveRack™ and run to the selected speaker amplifier.
3. Making sure that all outputs are muted, apply power to the mixer and amplifiers.

Software

1. Select a program (Factory: 2x6 Stereo) as a template.
2. Load the program by pressing the PROG/CONFIG button.
3. Adjust the individual parameters for the system by pressing the Processing Module buttons

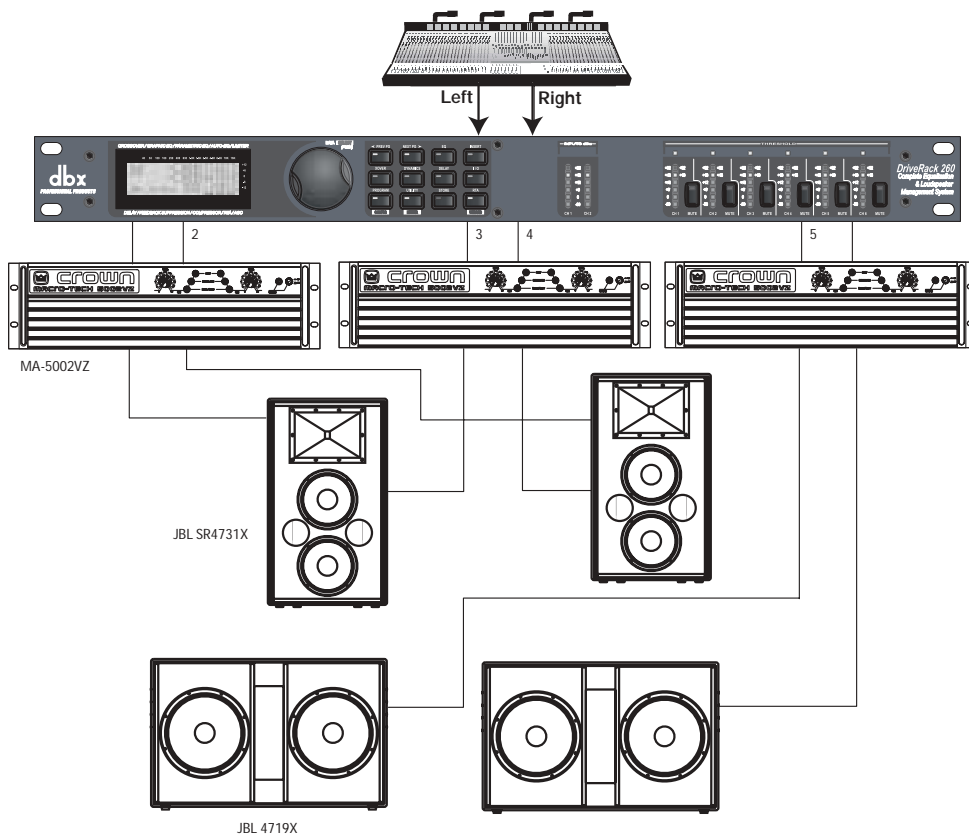

7.3 Stereo with Four Aux Zones

Hardware

1. Connect the outputs from the mixer to the inputs of the DriveRack™.
2. Connect the outputs of the DriveRack™ and run to the selected speaker amplifier.
3. Making sure that all outputs are muted, apply power to the mixer and amplifiers.
4. Make connections between the Zone Controllers (see Section 6.2) and the 260.

Software

1. Select a program (Factory: 2x2 w/ 4 Zones) as a template.
2. Load the program by pressing the PROG/CONFIG button.
3. Save multiple copies of this program to be recalled by the ZC-3 Controller.
4. Adjust the individual parameters for each of the programs by pressing the Processing Module buttons.
5. Using the Utility Menu, select the ID for each ZC-1 and ZC-2 Zone Controller and program its output level boost and cut parameters.
6. Using the Utility Menu, select the ID for the ZC-3 Zone Controller and select the programs that the ZC-3 will load from each of its positions.

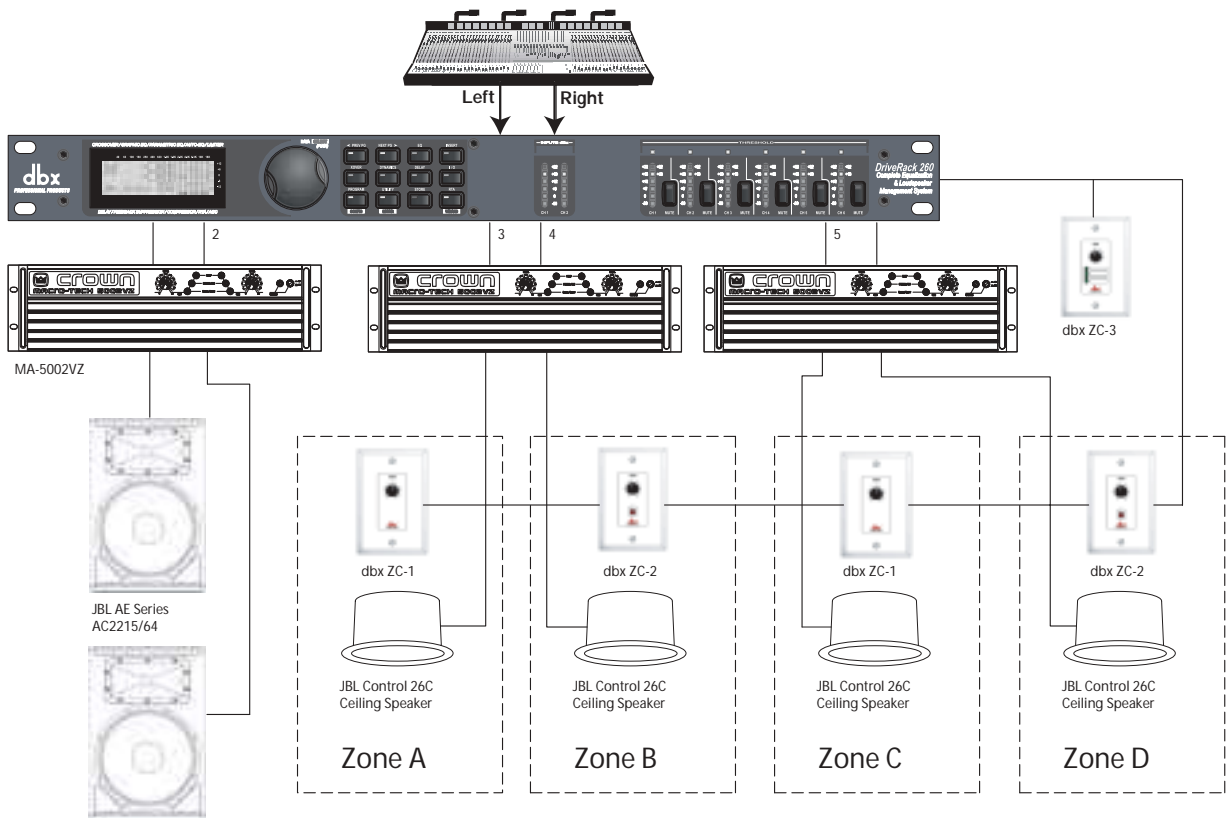

7.4 - Stereo Bi-amp w/ Dual Delay

Hardware

1. Connect the outputs from the mixer to the inputs of the DriveRack™.
2. Connect the outputs of the DriveRack™ and run to the selected speaker amplifier.
3. Making sure that all outputs are muted, apply power to the mixer and amplifiers.
4. Make connections between the Zone Controllers (see Section 6.2) and the 260.

Software

1. Select a program (Factory: 1x4 w/ 2 Zones) as a template.
2. Load the program by pressing the PROG/CONFIG button.
3. Adjust the individual parameters for the system by pressing the Processing Module buttons.
4. Using the Utility Menu, select the ID for each ZC-1 and ZC-2 Zone Controller and program its output level boost and cut parameters.

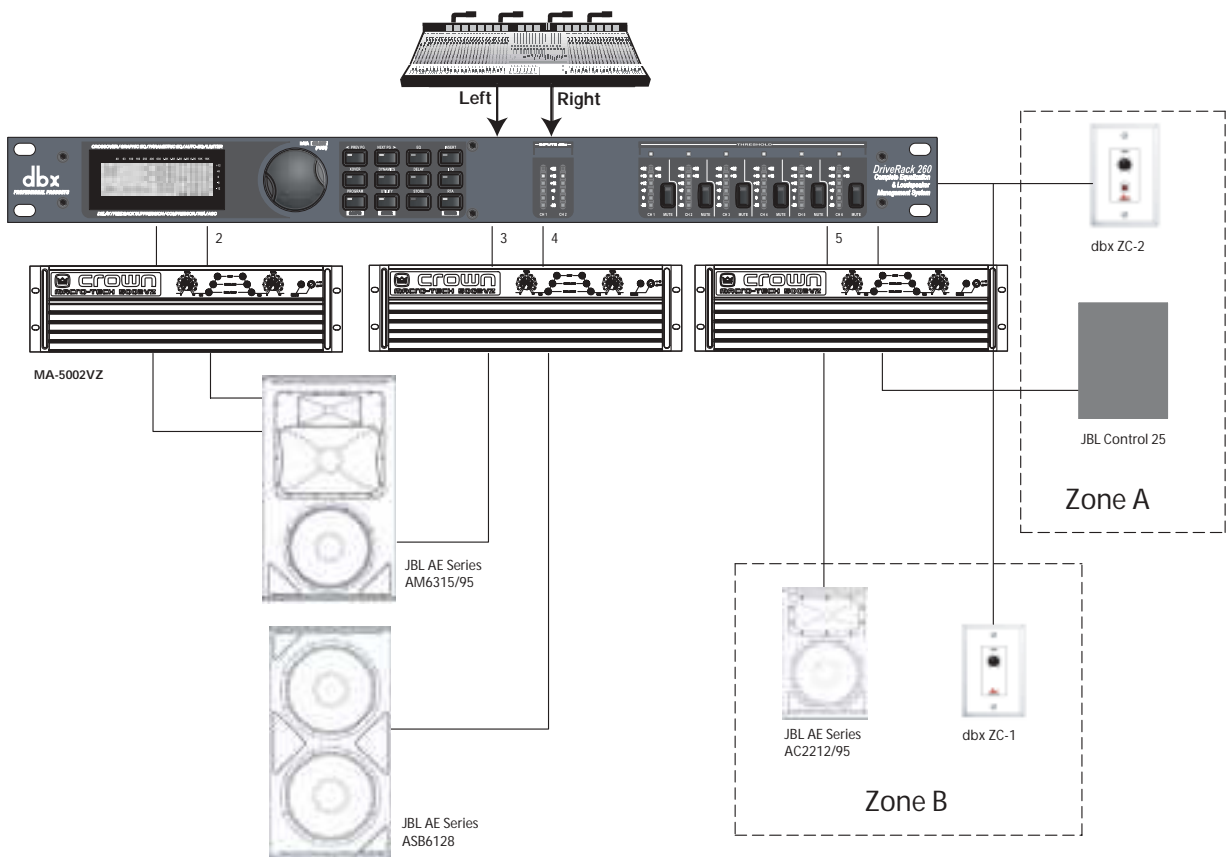

DriveRack™

Appendix



dbx[®]
PROFESSIONAL PRODUCTS

A.1 Factory Reset

In the event that a reset is required, the DriveRack™ 260 offers you the option of performing a “Soft” or “Hard” reset. The Soft Reset resets all operating parameters except user programs. The Hard Reset Procedure will reset all program-mable information back to the factory defaults.

All Power-Up Functions require a button(s) to be pressed and held as the unit power is turned on.
DriveRack 260 Power-Up Button Functions

Factory (“Hard”) Reset.

Press and hold the <STORE> button at power-up until the following message appears:

```
<! HARD RESET?
<Yes <PREV PAGE>
<No <PROGRAM>
```

- Pressing the <PREV PAGE> button will start a Factory Reset (All User Programs will become copies of the Factory Programs, all Utility settings will be defaulted, and all Security settings will be defaulted).
- Pressing the <PROGRAM> button will abort the Factory Reset sequence and the unit will reset normally.

System (“SOFT”) Reset

- Press and hold the <UTILITY> button at power-up until the following message appears:

```
<! SOFT RESET?
<Yes <PREV PAGE>
<No <PROGRAM>
```

- Pressing the <PREV PAGE> button will start a System Reset (All Utility settings will be defaulted.)
- Pressing the <PROGRAM> button will abort the System Reset sequence and the unit will reset normally.

A.2 Power Up Quick Key Options

The DriveRack™ 260 offer several “Quick Key” options for initial power up and are as follow:

Change Initial Program Number

- To change the initial power program number, Press and hold the <PROGRAM> button at power-up until the following message appears:

```
Use Wheel to Change Restart Program Number
```
- Turning the <DATA> wheel will select the program you wish to load at initial reset.
- Press the <PROGRAM> button again when the selection is complete. Normal resetting will continue.

System Lock Out

- Press and hold <RTA> at power-up until one of the following messages appears:

```
System Unlocked All user input will be accepted
or
```

```
System Locked No user input will be accepted
```

- Rotating the <DATA> wheel to select either Lock, Unlock or Filter Unlocked the system.
- Pressing <PREV PAGE> will unlock the system if it were locked or it will lock the system if it were unlocked.
- If you wish to leave the system locked with the exception of being able to clear the feedback filters, follow the same procedure on power up and then rotate the <DATA> wheel to select the feedback filter unlock feature.
- Pressing any other button will abort the System Lockout sequence and the unit will reset normally.

A.3 Specifications

Analog Inputs:

Number of Inputs:	(2) Line inputs, (1) RTA Mic input
Connectors:	(2) Female XLR line inputs, XLR RTA Mic input
Type:	Electronically balanced/RF filtered
Impedance:	> 40k Ω
Max input line level:	+20dBu
CMRR:	> 45dB
RTA Mic Phantom Voltage:	+15VDC
RTA Mic EIN:	< -117dBu, 22Hz-22kHz, 150 Ω

Analog Outputs:

Number of Outputs:	(6) Line Outputs
Connectors:	Male XLR
Type:	Electronically balanced, RF filtered
Impedance:	120 ohms
Max Output Level:	+20dBu
Alignment Delay:	10ms per channel (60ms total)

A/D Performance:

Type:	dbx Type IV conversion system
Dynamic Range:	>107 dB unweighted, >110 dB A-weighted
Type IV dynamic range:	123 dB with transient material, A-weighted, 22kHz BW 121 dB with transient material, unweighted, 22kHz BW 115 dB typical with program material, A-weighted, 22kHz BW
Sample Rate:	48kHz

D/A Performance:

Dynamic Range:	112 dB A-weighted, 110dB unweighted
----------------	-------------------------------------

System Performance:

Dynamic Range:	110 dB unweighted, >107dB weighted,
THD+N:	0.002% typical at +4dBu, 1kHz, 0dB input gain
Frequency Response:	20Hz - 20kHz, +/- 0.5dB
Interchannel Crosstalk:	>110dB, 120dB typical
Crosstalk input to output:	>100dB

Power Supply:

Operating Voltage:	DO: 100-120VAC 50/60 Hz - EU: 220-240 VAC 56/60 Hz,
Power Requirements:	25 Watts

Physical:

Weight:	5.5 lbs.(2.5 kg) Shipping weight 7 lbs. (3.18 kg)
Dimensions:	1.75" H x 5.75" D x 19" W

A.4 Auto EQ Optimization Tips

By using the setup wizard, cross over output gains and post cross over parametric EQ settings are set to match your system. The Auto-EQ can be used to adjust your system to compensate for room effects, and adjust the response of the entire system to your liking. After allowing Auto EQ to “pink the room” your system will sound tighter. The low end will have more definition, the mids will be more intelligible, and the highs can be tamed. Here are two things to look for to get the best performance from the Auto-EQ.

Look out for Modes

Some speaker and RTA microphone positions will result in certain frequencies canceling out. The resulting modes can not be corrected with equalization. The Auto-EQ does not detect modes in the frequency response, so may try to boost a band to compensate for a mode with out positive affect. You may be able to see if a lifted band is a mode by manually adjusting a lifted EQ band - if no change in the EQ is perceived, you probably are seeing a mode in your frequency response. To reduce the effect of this mode, try different microphone positions and adjust the location of your speakers, then re-pink the room for a more effectual Graphic EQ adjustment.

Adjust Cross Over Output Gains

If your system setup or the response you have chosen results in the Auto-EQ lifting or cutting a number of consecutive bands of the Graphic EQ, you can adjust the level of the associated cross over output gain to match the average boost or cut in the graphic EQ and re-pink your room. This time, the adjustment of the Graphic EQ bands will be less “heavy handed” and the system will sound better having fewer phase problems and a lower noise floor than a more aggressively adjusted Graphic EQ. With the rest of your system properly adjusted, the Auto EQ can compensate for room resonance and adjust to suit personal taste without large excursions in the Graphic EQ bands.

A.5 Crossover Diagrams

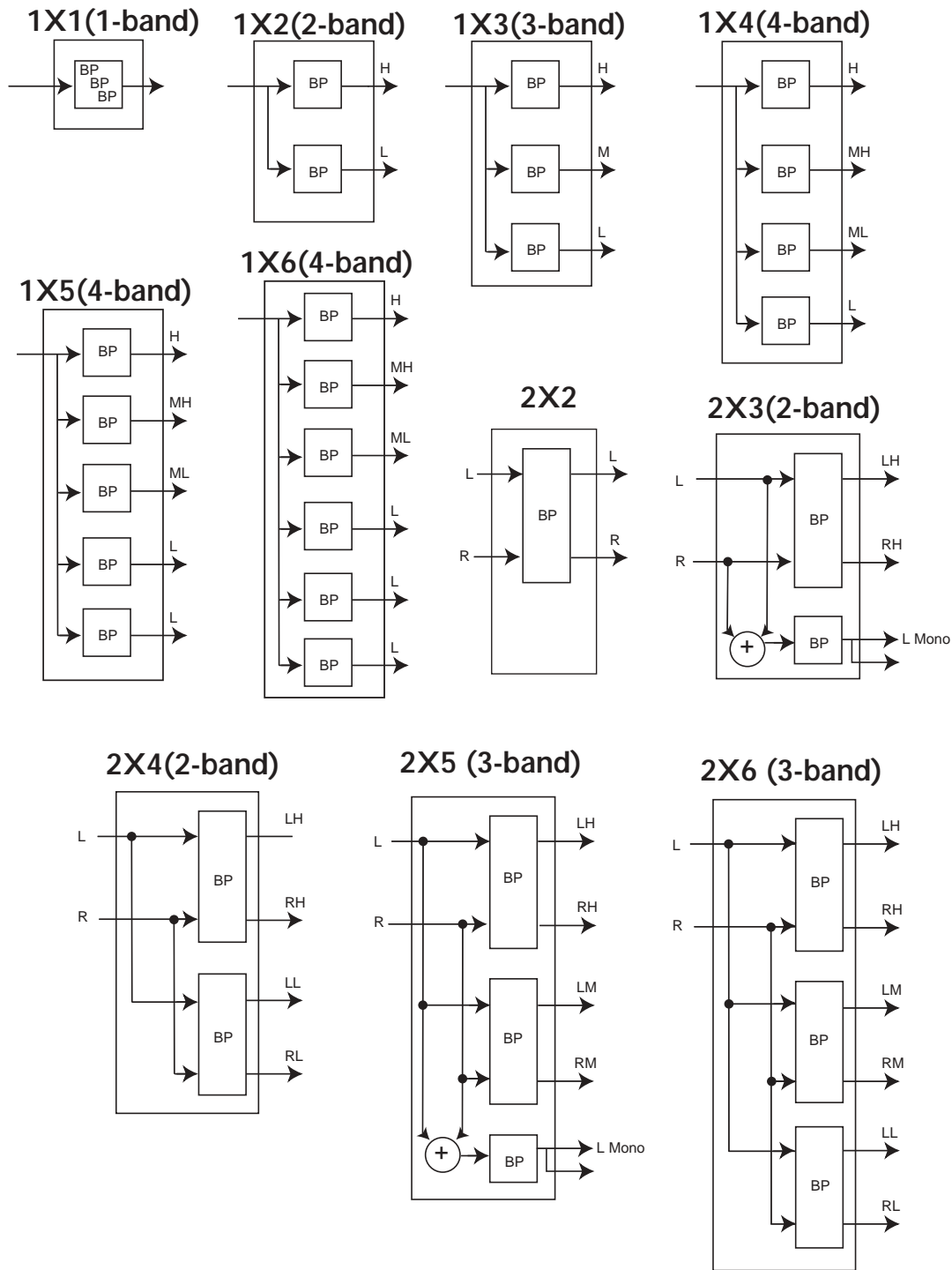

A.6 Program List/ Speaker Tunings/ Power Amp Tunings

Factory Program List

1. 2x3w/3Zones
2. LCRw/Cluster
3. 1x4w/2Zones
4. 2x5w/1Zone
5. 2x4Tri-Amped
6. 2x4w/2Zones
7. LCRw/Monitor
8. STw/2Delays
9. Multi-Zone
10. 2x3w/Bal&Dly
11. AM4315/64
12. AC2215/64
13. SR4731X
14. AM6340/95
15. EON15G2
16. AM4212/95
17. MP412
18. SR4735X
19. AC2212/00
20. AM6315/64
21. AC2215/00
22. SF25
23. SR4722X
24. AC2212/95
25. AM6212/64

Main Speakers

- AM6340/95
- AM6340/64
- AM6340/95 (With assumed external Sub)
- AM6340/64 (With assumed external Sub)
- AM6315/95
- AM6315/64
- AM6315/95 (With assumed external Sub)
- AM6315/64 (With assumed external Sub)
- AM4315/95
- AM4315/64
- AM6200/95
- AM6200/64
- AM4200/95
- AM4200/64
- AM6215/95
- AM6215/64
- AM4215/95
- AM4215/64
- AC2215/95
- AC2215/64
- AC2215/00
- AM6212/95
- AM6212/64
- AM6212/00
- AM4212/95

- AM4212/64
- AM4212/00
- AC2212/95
- AC2212/64
- AC2212/00
- SR4702X
- SR4722X
- SR4725X
- SR4726X
- SR4731X
- SR4732X
- SR4733X
- SR4735X
- MP212
- MP215
- MP225
- MP410
- MP412
- MP415
- EON1500
- EON10G2
- EON15G2
- SF15
- SF25
- FR129Z
- FR159Z
- FR153Z
- S112IV
- S115IV
- S215IV
- C300
- S500
- Eliminator i
- V152
- V122
- Custom

Low Speakers

- None
- AL6115
- AL6125
- Custom

Sub Speakers

- None
- AL6115 (With assumed external Sub)
- AL6125 (With assumed external Sub)
- ASB6118
- ASH6118
- ASB6128
- ASB4128
- ASB6128V
- SR4715X

- SR4718X
- SR4719X
- MP418S
- MP418SP
- MP255S
- EONSUBG2
- SF22SP
- FR250Z
- SW118IV
- SW215IV
- Eliminator i Sub
- SUB18B
- SUB15
- Custom

Power Amplifiers

- Crown XLS 202
- Crown XLS 402
- Crown XLS 602
- Crown CE 1000
- Crown CE 2000
- Crown CE 4000
- Crown CL1
- Crown CL2
- Crown CL4
- Crown CH1
- Crown CH2
- Crown CH4
- Crown CTS 600
- Crown CTS 1200
- Crown CTS 2000
- Crown CTS 3000
- Crown CTS 4200
- Crown CTS 8400
- Crown PowerTech 1.1
- Crown PowerTech 2.1
- Crown PowerTech 3.1
- Crown K1
- Crown K2
- Crwn MacroTech 1202
- Crwn MacroTech 2402
- Crwn MacroTech 3600
- Crwn MacroTech 5000
- Custom

Powered-Subs

- EON10G2
- EON25G2
- MP418SP
- EONSUBG2
- SF22SP

A.7 Block Diagram

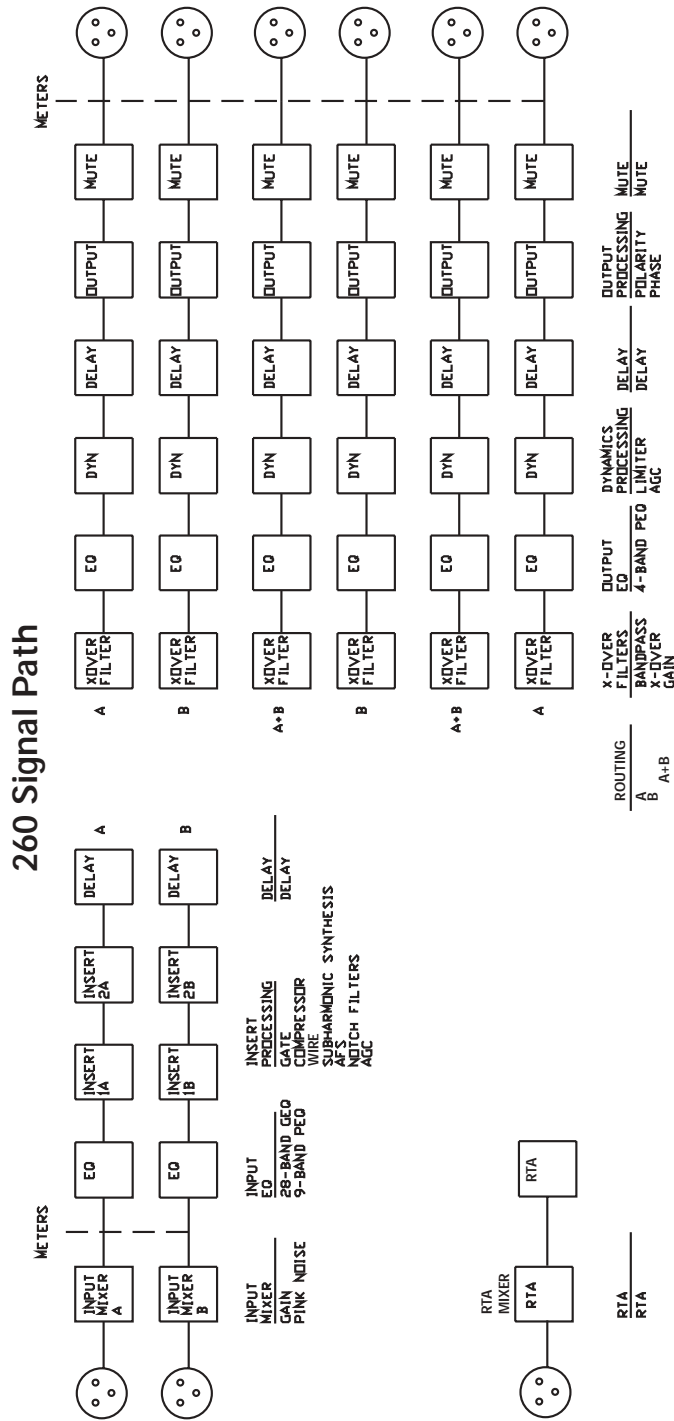

A.8 Input and Output Diagrams

INPUT DIAGRAM

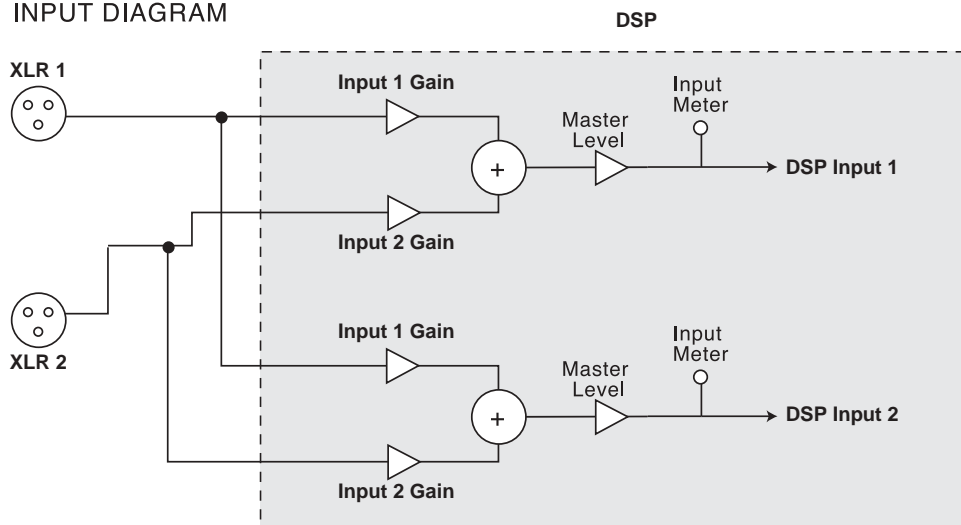

OUTPUT DIAGRAM (repeat for each XLR OUTPUT)

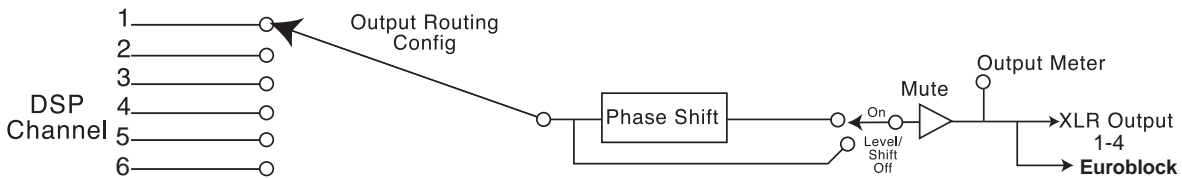

A.9 Gain Level Jumpers



CAUTION: These servicing instructions are for use by qualified service personnel only. To reduce the risk of electric shock, do not perform any servicing other than that contained in the operating instructions unless you are qualified to do so. Refer all servicing to qualified service personnel. Disconnect mains power before servicing.



The 260 DriveRack gives you the option of changing the input gain level settings. There are 3 hardware configurable gain settings. They are: +14 dBu, +22 dBu and +30 dBu. For these cases, use the following procedure to change the gain level settings. Please be advised however, that once the gain level has been changed from the factory settings, the output meters will no longer be calibrated correctly.

To change the gain level, move the jumpers to the pins that are marked with the desired gain setting

- 1) First, make sure that the unit has been shut off and unplugged prior to opening the unit.
- 2) Ground yourself prior to opening the DriveRack™ chassis to prevent ESD damage.
- 3) Open the chassis by removing five screws on each side of the chassis and the top two center screws on the rear panel, as well as the top center allen screw located on the front panel
- 4) Locate the jumper block shown in the illustration below:

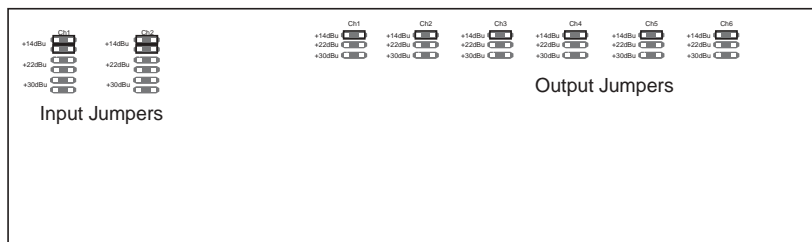

A.10 System Setup and Gain Structure

The DriveRack 260 offers a wide range of tools for sound system design and setup. These tools can make your system more efficient and better sounding, but to get the best possible sound it is important to use these tools properly. In the DriveRack 260 we have included a Wizard setup tool to help in system setup. If you use the Wizard to set up your DriveRack 260 it will automatically set the limiters for some amplifier selections. If your amplifiers are not available in the Wizard, you should choose the Custom setting. The following section explains how to maximize system gain and how to use the limiters to protect your amplifiers from clipping.

In traditional system design, the output of your console would be routed to a system EQ, a compressor, and a crossover with output level control. From the crossover, there may be additional filters that are employed to improve the response of your speakers. There may also be limiters set up to keep your amplifiers from going into clipping and protect your speakers from the hazards of a clipped signal. Your amplifiers play a vital role in system setup, because they are last item in the chain before your speakers and offer the greatest amount of gain (that is their job after all). If your amplifiers are incorrectly setup you will not be using your system to its fullest potential and could be harming your speakers.

One thing that is critical to system setup is maximizing gain structure. Gain structure refers to aligning the gain of each device so that they all clip at the same point, and the noise floor of the entire system is at its absolute minimum. Quite often PA systems are setup with the amplifier input controls turned all the way up in the incorrect assumption that this is the only way to get the maximum output level. Amplifiers are fixed gain devices, turning down the amplifier input attenuators does not change the potential output of the amplifier; it only requires more input voltage to get full output power. Many amplifiers will clip with an input level greater than +6 dBu when the input attenuators are turned all the way up. Most mixing consoles can deliver over +18 dBu of output level before clipping. This means that with your amps tuned all the way up you are sacrificing 12 dB of headroom, resulting in poorer noise performance and the potential of system clipping. By adjusting the amplifier controls properly, you can maximize your system performance.

A way to set up your amplifiers for maximum gain structure is to use the clip indicators of the console and amplifiers themselves. Disconnect the output of the amplifier from the speakers. Run a continuous signal (pink noise or sine waves – many test CDs are available that have these types of signals) through your console. Turn up the output of the console until it begins clipping. If there is no clip indicator on the console then use the output meters; most reputable console manufacturers use red LEDs at the top of the meters to show the onset of clipping. Once the console is clipping, back the output gain down slightly until the clip indicator turns off. Run this signal through the DriveRack 260 and into the amplifiers with the crossovers and output gain section in the DriveRack 260 set for your particular speakers. Make sure that the output limiters are turned off. Run this signal into the amplifiers and turn up the input attenuators until the amplifier clip indicator begins to turn on. Turn the attenuators down slightly, so the clip indicator no longer is on. You have just maximized the gain through your system. This amplifier setting should give you maximum gain without clipping, another way of say this is that when the output of your console is clipping you will also be at the clip point of your amplifiers.

Once you have found the clip point of your amplifiers, you can mark this position and turn the amplifiers back up to the point where they are clipping. You can now use the output limiters in the DriveRack 260 to protect the amplifier from clipping no matter what you do at the console. With the amplifiers clipping, now go to the Limiter page of the DriveRack 260 and turn the limiter for each output band on. Make sure that the threshold is all the way up to +20dB. Now slowly reduce the threshold until the clip indicator of the amplifier turns off. You have successfully set the output limiter up and the amplifier will not be able to go into clipping no matter what the input is. You should now proceed to the next output band and go through the same process. If you are using a sine wave to create clipping in your amplifier you should make sure that the sine wave is within the frequency range of the output band that you are working with. Once all the limiters are set up you can now turn the amplifiers back down to the gain maximized position. The Wizard will automatically set your limiters based on your choice of amplifier. Because of component variances within the amplifier circuitry, you may need to adjust the limiter settings by a few dB after running the Wizard to ensure that they are set correctly. Once all the limiters are set up and the gain is maximized, reduce the output of your console and reconnect your speakers. Now for the fun part, sit back and send your favorite music through the system. If your system is not loud enough, you may want to consider an amplifier or amplifiers with greater output power. Most loudspeaker manufacturers recommend an amplifier that can provide 1.5 to 2 times the rated RMS power of the speaker. If this setting is too loud when your speakers are reconnected you can turn down the amplifier input attenuators even more.



PROFESSIONAL PRODUCTS

8760 South Sandy Parkway • Sandy, Utah 84070

Phone: (801) 568-7660 • Fax (801) 568-7662

Int'l Fax: (801) 568-7583

Questions or comments?

E-mail us at: customer@dbxpro.com or visit our

World Wide Web home page at:

www.dbxpro.com or

www.driverack.com

H A Harman International Company